

The Dock Doctors[®] LLC

Waterfront Specialists

Pick Up > We Pay
of Free Delivery

see page 3

2024 Stock Catalog



Accessories



Aluminum Stairs



Boat Lifts



Paddle Products

Free Dock Design Service

Our experienced staff will create a **FREE dock layout** and estimate designed to your specific site and individual needs.

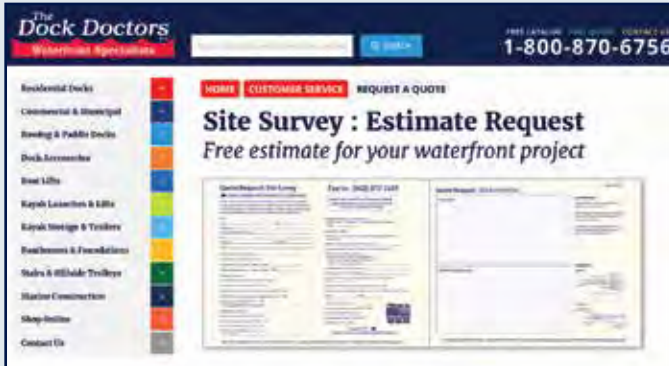

www.thedockdoctors.com/site-survey

or call us at: **800-870-6756**



See our Custom Catalog

www.thedockdoctors.com/catalogs

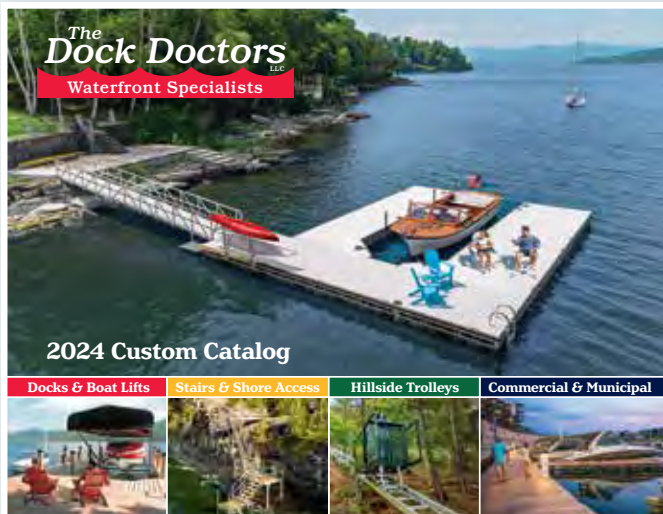

Stock Docks - Leg and Floating (pp. 22-51) readily available for pickup or delivery



Swim Floats & Pond Docks (pp. 4-7)



Dock Options & Accessories (pp. 8-18)



Aluminum Stairs (pp. 19-21)



Paddle Products (pp. 52-67)



Boat Lifts & Canopies (pp. 68-80)



Free Curbside Delivery* (p. 3)



Installation Services (p. 81)



The Dock Doctors[®] Waterfront Specialists



Manufacturing Facility &
Vermont Year-Round Showroom



Warehouse & Distribution

Take a virtual tour of our facility at:
www.thedockdoctors.com/tour

Factory Direct from our door to yours

Local delivery &
installation available
throughout the
Northeast



Nationwide
Shipping

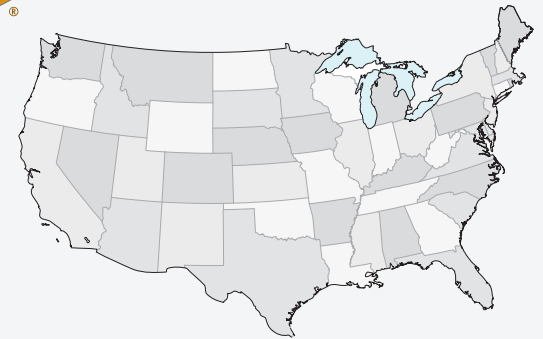

800-870-6756

www.thedockdoctors.com

info@thedockdoctors.com

Pricing Disclaimer – Printed pricing throughout this catalog and our website are subject to change due to the fluctuation of raw materials, fuel and other manufacturing costs.

© Copyright 2024

Look for the red truck throughout our catalog for products that qualify for free delivery* or pick up & save**!

Pick Up > We Pay
OR Free Delivery



Free Delivery

our trucks deliver curbside* to your site

| Minimum Purchase Amount (not including sales tax) | Free Delivery from Ferrisburgh, VT (distance based on Google Maps) | Delivery Charge One-Way (over the free mile range) |
|--|---|---|
| \$ 2,000 | 25 miles | \$4. ⁰⁰ / mile** |
| \$ 4,000 | 50 miles | \$4. ⁰⁰ / mile** |
| \$ 6,000 | 100 miles | \$4. ⁰⁰ / mile** |
| \$ 8,000 | 150 miles | \$4. ⁰⁰ / mile** [^] |
| \$ 10,000 | 200 miles | \$4. ⁰⁰ / mile** [^] |

OR

Pick Up & Save

we will pay you to pick up[†]



| Minimum Purchase Amount (not including sales tax) | Pick Up Discount |
|--|------------------|
| \$ 2,000 | \$75.00 |
| \$ 4,000 | \$150.00 |
| \$ 6,000 | \$300.00 |
| \$ 8,000 | \$450.00 |
| \$ 10,000 | \$600.00 |

*** Free Curbside Delivery Terms & Conditions:** 1. Curbside delivery definition: We will back up as close as we can with our vehicle to your installation site and off-load your product. We cannot carry your product further than the side/rear of our truck/trailer. Our delivery vehicles cannot go off of approved driveway surfaces (ie on grass, etc.). 2. Free delivery available on The Dock Doctors® Stock Products only. Please see chart above for minimum purchase amounts to qualify for free delivery. Free delivery does not apply to Rowing or Paddle Docks or Ultimate Boat Lifts. 3. Boat Lifts, canopies & accessories – free delivery applies to products in stock only. 4. If you want your product installed, please inquire on rates for this service – free delivery does not apply. 5. Additional fees apply for wide loads (assembled boat lifts) & ferry charges, if needed. 6. Purchases under \$2,000 are subject to a \$4.00 per mile one way charge from Ferrisburgh, VT. A ground shipping method/charge by another source such as Common Carrier or UPS may be more feasible depending on product purchased. 7. [^] Due to regulations for hourly driving restrictions by the Federal Motor Carrier there may be an additional fee applicable to deliveries 200 miles or over for overnight charges. 8. Large loads may require assistance on site to off-load.

**** Pickup & Save Conditions:** 1. Applies to pickup at our Ferrisburgh, Vermont warehouse, arranged by the customer. 2. Available on The Dock Doctors® Stock Products only. Please see chart above right for minimum purchase amounts to qualify for pickup and save. Does not apply to Rowing or Paddle Docks or Ultimate Boat Lifts. 3. Boat Lifts, canopies & accessories – pickup and save applies to products in stock only.

Swim Floats : Aluminum & Galvanized Steel Frames



8' x 8' aluminum swim float with cedar decking.

Aluminum Swim Float

Ideal for calm bays or small bodies of water

- Lightweight one-piece aluminum frame
- Removable decking panels
- Stocked in 8' x 8' size

8' x 8' Aluminum Swim Float with removable deck panels shown with 3' ladder



Aluminum Ladder (see page 18)

3 foot: **\$305** 4 foot: **\$325** 5 foot: **\$345**



Aluminum Swim Float (shown above)

Ideal for use in small lakes or calm bays. One piece lightweight aluminum frame with polyethylene floats. Removable decking panels. Optional ladder and anchoring sold separately.



| Stock Size | Weight* | CEDAR | | WEARDECK® | |
|------------|----------|--------------|----------|--------------|----------|
| | | Net Buoyancy | Price | Net Buoyancy | Price |
| 8' x 8' | 162 lbs. | 865 lbs. | \$ 2,135 | 787 lbs. | \$ 2,505 |

*Weights for swim floats do not include the decking. Custom size swim floats available, please contact us for details. See decking details and color choices on page 8.

Light Duty Float Harness

Includes shackles, swivel, 3' of 3/8" chain & (2) 10' nylon ropes. **\$125**

Nylon Rope Extension

Amount needed is 1.5 x the water depth

14' (**\$59**), 18' (**\$61**), 22' (**\$63**)

Concrete Anchor (Light Duty)

18" x 8", 180 lbs. **\$145**



For more info on anchoring, visit: www.thedockdoctors.com/swim-float-anchoring



8' x 8' galvanized steel swim float with cedar decking.

Pick Up > We Pay
or Free Delivery
see page 3

Galvanized Steel Swim Float (shown above)

Ideal for rough water. Dismantles into two pieces for ease of handling. Removable decking panels. Optional ladder and anchoring sold separately.



| Stock Size | Weight* | CEDAR | | WEARDECK® | |
|------------|----------|--------------|----------|--------------|----------|
| | | Net Buoyancy | Price | Net Buoyancy | Price |
| 8' x 8' | 238 lbs. | 789 lbs. | \$ 2,230 | 711 lbs. | \$ 2,595 |
| 8' x 10' | 248 lbs. | 778 lbs. | \$ 2,495 | 638 lbs. | \$ 2,975 |
| 10' x 10' | 476 lbs. | 1,787 lbs. | \$ 3,385 | 1611 lbs. | \$ 3,980 |

*Weights for swim floats do not include the decking. Custom size swim floats available, please contact us for details. Ipe hardwood or other composite decking options available. See decking details and color choices on page 8.

Heavy Duty Galvanized Steel Swim Float

Heavy-duty, ideal for rough water

- Two-piece galvanized steel frame
- Removable decking panels

8' x 8' Galvanized Steel Swim Float with removable deck panels shown with 3' ladder



Heavy duty galvanized steel swim float dismantles into two pieces for ease of handling.

Aluminum Ladder (see page 18)

3 foot: **\$305** 4 foot: **\$325** 5 foot: **\$345**

Heavy Duty Float Harness

Includes shackles, swivel & (2) 10' nylon ropes. Chain sold separately. **\$195**

Galvanized Chain

Amount of chain needed is 1.5 x the water depth. **\$4.⁹⁵/foot**

Concrete Anchor (Heavy Duty)

2' x 2' x 8", 400 lbs. **\$175**



For more info on anchoring, visit: www.thedockdoctors.com/swim-float-anchoring



A 4' x 16' Pond Dock
galvanized steel frame

Designed for ponds or bodies of water with little to no wave activity or water level fluctuation.



B 4' x 20' Pond Dock
galvanized steel frame

Pond Docks

Available in a galvanized steel frame or 4-piece aluminum frame.

- Removable decking panels
- Galvanized steel frame pond docks available in 4' x 16' and 4' x 20' sizes
- 4-piece aluminum frame pond dock available in 4' x 18' size, designed for common carrier shipping
- Optional aluminum ladder (see p. 18)

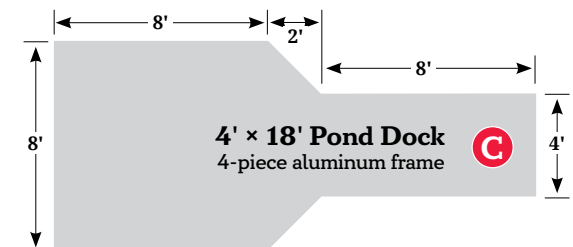
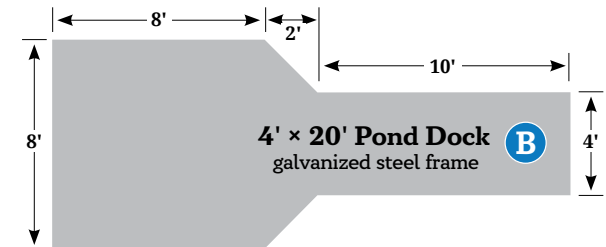
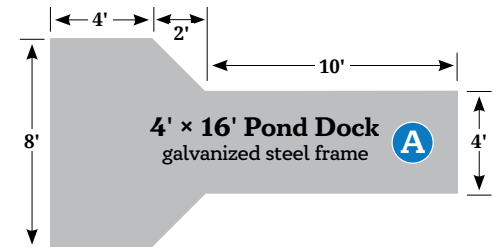



4' x 18' Pond Dock
4-piece aluminum frame
(shippable)

Ships on a 4' x 10' pallet
or contact us about local delivery (see p. 3)

Calculate shipping to your location at:
thedockdoctors.com/aluminum-pond-dock

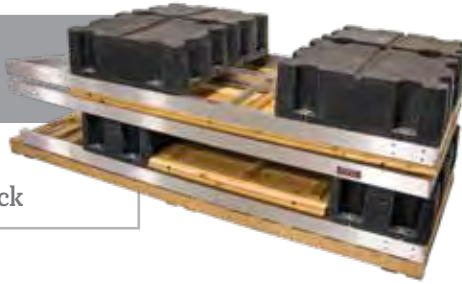

C 4' x 18' Pond Dock
4-piece aluminum frame

Pond Docks

All pond docks feature removable decking panels and black polyethylene floats. Includes (2) 3 ft. long 1 1/2" pipes with safety caps for shore anchoring.

| Stock Size | Weight* | Decking Options | |
|---------------------------------|----------|-----------------|-----------|
| | | CEDAR | WEARDECK® |
| | | Price | Price |
| Galvanized Steel Frame | | | |
| A 4' x 16' pond dock | 289 lbs. | \$ 3,025 | \$ 3,775 |
| B 4' x 20' pond dock | 410 lbs. | \$ 4,060 | \$ 5,020 |
| Aluminum Frame (4-piece) | | | |
| C 4' x 18' pond dock | 322 lbs. | \$ 4,085 | \$ 4,980 |

*Weights for pond docks do not include the decking. Ipe hardwood or other composite decking options available (4' x 20' pond dock only). See decking details and color choices on page 8.

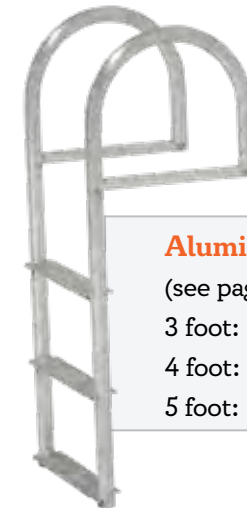

Aluminum Ladder

(see page 18):

3 foot: **\$305**

4 foot: **\$325**

5 foot: **\$345**

Options & Accessories : Decking Choices

Choosing the decking for your new dock system is an important choice, and there are many factors to consider. Maintenance, cost, color and personal style-preferences.



CEDAR is a natural, cost effective decking option that is naturally resistant to decay and insects. We use STK Western Red Cedar (Select Tight Knot Grade or Number 2). It is generally regarded

as a high-quality choice for cedar, and any knots present are sound encased and tight. The wood is generally straight-grained and has a uniform, but rather coarse texture.

CONS: Over time, cedar will absorb moisture and weather to a soft silvery gray, unless sealed with a preserving stain.



ALUMINUM resists the growth of mold and mildew and won't rust, rot, split or stain. This painted then baked beige finish eliminates glare from the aluminum.

The non-slip, rigid, surface is

low-maintenance and cool to the touch. Color is Sherman Williams Beige PHT160052.

CONS: Can sound metallic when walking on it, especially on our docks with removable panels.



WEARDECK is a high density polyethylene resin with UV inhibitors. WearDeck's 5/4" thick deck board is rated to span joists 24" on center with the highest live load capacity in the industry. Rated for ground and underwater contact and will not support mold or mildew growth. This product is 100%

manufactured in Ocala, FL and offers a 25 year commercial

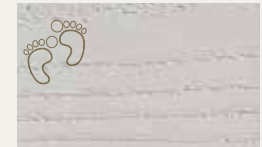

(A) Barefoot Gray



(B) Barefoot Sand



(C) Weatherwood



*please inquire for pricing and lead times.



and a lifetime residential warranty.

Cons: Not a natural wood.

Barefoot Collection
"Lighter Colors, Cooler Touch"

Heat-Reflective Technology

- Reflects the sun's hot rays off the surface of the board
- Reduces surface temperature by at least 30% on each color

Ipe Hardwood Decking Upgrade



IPE is extremely hard, very durable and naturally resistant to rot and insects. Ipe's strong, resilient properties make it an excellent material choice for marine applications.

Cons: Due to the density of Ipe, it is heavy and hard to drill and cut, therefore more labor intensive than working with other decking materials. It is also a natural wood, therefore there will be inconsistencies with regard to color, weathering and texture.



SURE-STEP is a slip-resistant, polypropylene surface that allows water and sunlight through to help conserve the underwater ecosystem. Preferred option for dock structures that are situated close to the water so waves will pass

through the decking, adding minimal resistance. Color: Grey.

Cons: Only available in certain dimensions, so may not be a viable option for many applications.

This product **ONLY** available on our Standard Duty Aluminum Leg & Wheel Docks



Our heavy duty aluminum Paddle Dock shown on p. 52-53.

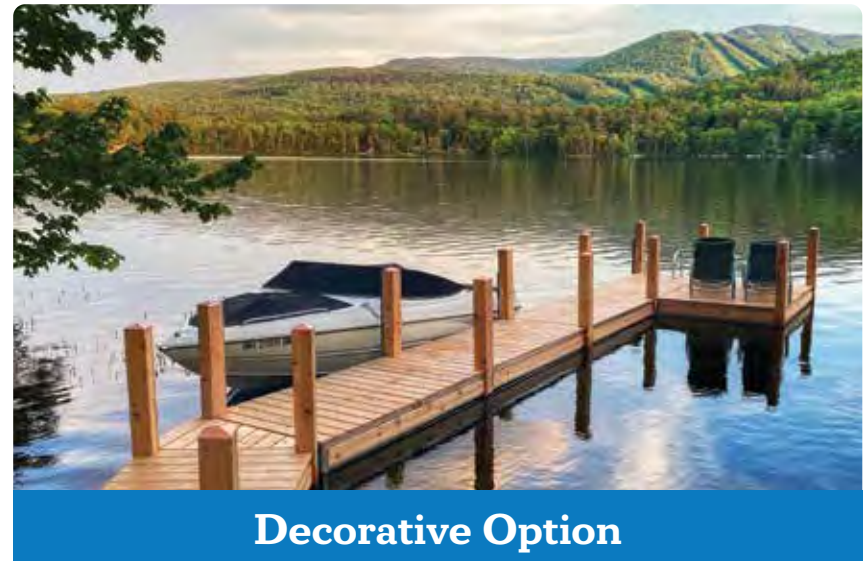

Wooden skirt-boards and cedar post covers are used to camouflage the steel truss frame and leg pipe, providing the appearance of a wooden dock system. Please inquire for pricing and details.



Shipping Available

Protect your boat and dock with our adjustable vertical fenders (available for all dock systems)

Our Vertical Fenders offer two forms of adjustment:

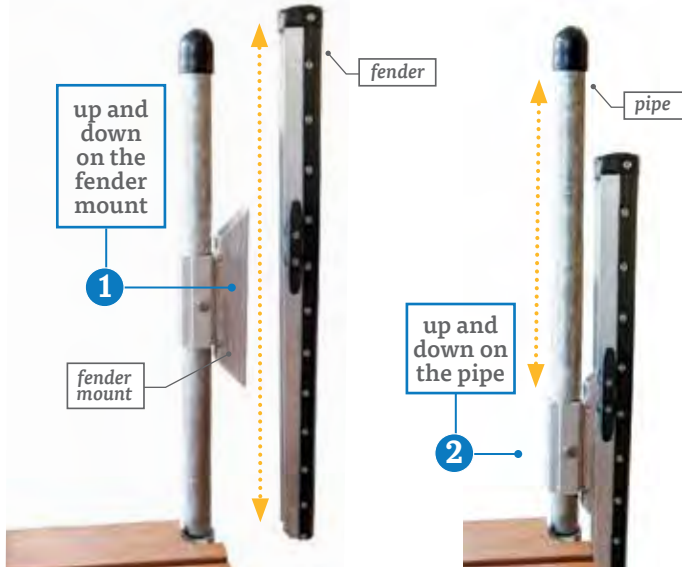

Our unique vertical fender design provides a double adjustment both on the fender mount & on the dock support pipe (see diagram above) – which is often necessary due to lake level and boat style. Add a fender cleat kit (see **G** on p. 11) for a complete securing system for your boat.

Our quality vertical fender material provides adequate cushion for protection – but is firm and slick enough to allow the boat gunnel to slide up and down without friction that could cause damage to seasonal docks.



Options & Accessories : Vertical Fenders, Cleats



| Vertical Fenders | | | | |
|---|---------------------|---------------|---------------|--|
| Fender Style | Mounting Style | 3' long | 4' long | |
| <i>For all Aluminum Leg & Wheel Docks & Steel Truss Leg Docks with 1 ½" pipe:</i> | | | | |
| A Fender | 1 ½" pipe mount | \$ 185 | \$ 205 | |
| B Double Corner Fender | 1 ½" pipe mount | \$ 335 | \$ 390 | |
| <i>For all Steel Truss Wheel Docks with 1 ½" pipe:</i> | | | | |
| C Fender with offset | 1 ½" pipe mount | \$ 195 | \$ 215 | |
| <i>For all Mega Leg Docks with 3" pipe or Custom Articulating Docks with 2" pipe:</i> | | | | |
| D Fender | 2" or 3" pipe mount | \$ 229 | \$ 249 | |
| <i>For all Aluminum "Track-Frame" Floating Docks:</i> | | | | |
| E Fender | Track Mounted | \$ 205 | \$ 225 | |
| <i>For all Aluminum "Track-Frame" Floating Docks - includes spud mount:</i> | | | | |
| F Fender | Spud Anchor Mounted | \$ 439 | \$ 459 | |

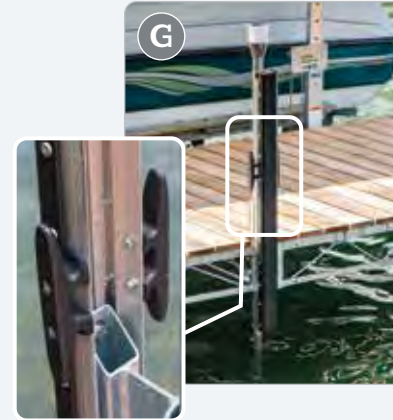

G Fender Cleat Kit

Designed to be used with the 3' or 4' fenders shown on page 10. Includes (2) cleats per kit that bolt onto the fender mount.

\$ 49 per kit

includes 2 cleats and hardware to attach to vertical fender

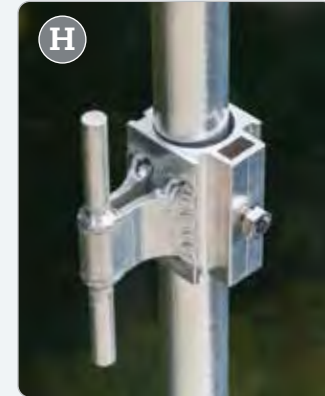

H Pipe Cleat (for 1 ½" pipe)

A single cleat mounted to a sleeve that slides over the leg pipe. Available for all leg & wheel docks except the mega leg & wheel docks.

\$ 44 each



I Track Cleat

Designed to slide along the track of our floating aluminum track dock systems.

\$ 29 each

Options & Accessories : Edge Fender, Mooring Whips



A Edge Fender

An alternative to our vertical fenders, this high quality, non-marring black edge fender can be installed on our Aluminum Leg & Wheel Docks (standard and medium duty), our Aluminum Floating Docks and our Custom Steel Truss Floating Docks.

\$ 9.⁹⁵ per foot

(material only, not installed, not including fasteners)

\$ 13.⁵⁰ per foot

(installed with stainless steel fasteners)*

**installation available on new dock orders only*



B Taylor Made Mooring Whips

Mooring whips with fixed angle base. Two-piece kit, will need to be epoxied (epoxy included with kit). Recommended for low profile boats such as bass boats, runabouts and sport boats.

MW120: **\$ 715** for 18' – 23' boats / 2,500–5,000 lbs.

MW140: **\$ 815** for 24' – 28' boats / 5,000–10,000 lbs.

Disclaimer: Some docking conditions may be too rugged for this product.

C Mooring Whip Dock Mounts (for Dock Doctors docks)

Required for docks with removable decking. **\$ 196** (for Taylor Made mooring whip models listed above only)



Heavy Duty and Mega Dock Truss Frame Mount



Aluminum Track Frame Mount

Options & Accessories : Dock Mounted Storage Racks

See our full line of Paddle Craft Products on pages 52-67

Dock Mounted Storage (Kayak, Canoe, Paddleboard)

Marine-grade aluminum small craft storage. Arms feature vinyl hull guards and end caps with built-in tie-down openings. Crafts can be secured with a cable and lock (not included).



Shipping Available



A Storage Arms (pair) (single craft, dock mounted)

A pair of storage arms which slide onto the leg pipes of your dock. Arms are 35" in length. *Note: Fits all docks with 1 1/2" pipe*.*

Storage Arms (pair): \$ 215

Designed for 1 1/2" SCH #40 pipe and will work with any pipe that measures 1-15/16" O.D. (outside diameter).



B Storage Rack (2-craft, dock mounted)

Our two-craft storage rack mounts to the frame of your dock and stores two crafts and paddles/oars. Top arm is 35", bottom arm is 18" (wider crafts can be stored at an angle).

Storage Rack (2-craft): \$ 655

Mounts available for all models of Dock Doctors docks, as well as a universal mount for wooden docks.



Options & Accessories : Boat & Paddle Craft Access



Lower Access Platform : for swimming & kayaking

Stationary leg docks are often quite a distance above the waters' surface, making accessing the water for swimming or kayaking very difficult. Our lower access platform is designed to provide you with a safe transition to the water.

- 5" tall aluminum frame
- Sure-Step® flow-thru, anti-slip decking
- Designed to be used alongside any 8'-10' long dock with 1 ½" support pipes
- Adjustable sleeves slide over 1 ½" support pipes

Lower Access Platform: \$975

add optional ladder (see p. 18)



Options & Accessories : Boat & Paddle Craft Access

A Dock Mounted Roller

A single 12" keel roller designed to assist you when moving canoes, kayaks, or other small crafts on or off your dock.

Dock Mounted Roller: \$ 145

A1 Universal Surface Mount or A2 Track Frame Mount for Dock Doctors Medium Duty Aluminum Floating docks (pages 46 - 51).

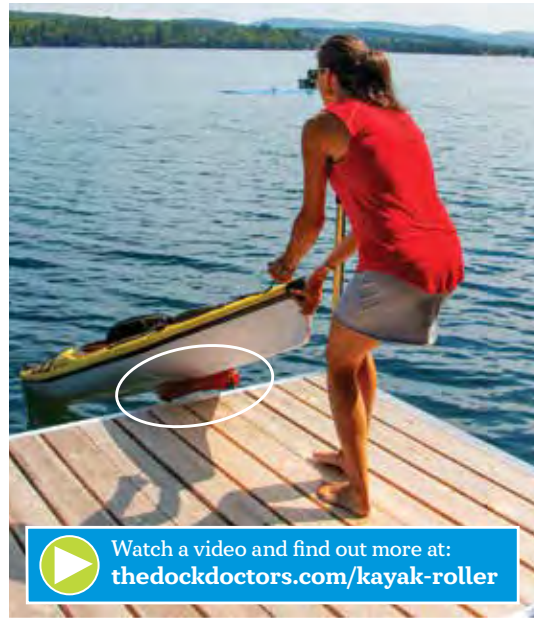

Watch a video and find out more at: thedockdoctors.com/kayak-roller

B Boarding Handle

Our marine-grade aluminum boarding handle provides a safe handhold when boarding your boat. Mounts to **Dock Doctors** floating aluminum track dock systems or universal mount to attach to any dock frame. Height from mount to top of handle is 48".

Boarding Handle: \$130

mount sold separately

B1 Universal Mount\$85

B2 Track Mount\$85

for Dock Doctors Medium Duty Aluminum Floating docks (pages 46 - 51).

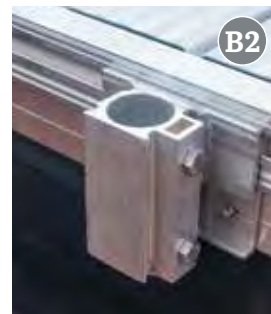

C Sliding Boarding Step *Great for people and pets!*

Our sliding boarding step easily slides and retracts so you can safely board your boat from your dock. Securely attaches to your existing dock. Includes a safety handrail that can mount to either side of platform. *See page 69 for full details and specifications.*

Sliding Boarding Step: \$1,155

Options & Accessories : Sea Gull Eliminators & Solar Lights



Solar Lighting options for your dock!
No Wiring Required and easy hassle free mounting.



Solar Dock Post Lites

Super bright LED (12 lumens) last 18+ hours on a full charge. Automatic night activation. Fits standard 1-1/2" and 2" pipes.

- Fully sealed electronic circuit board
- Replaceable 1.2v NiMH battery
- Two (2) post lites in each package

\$ 57
package of 2

Available with white LEDs only



1 3/8" Dock Dots

The smallest solar lights you have ever seen!

Easy to install in minutes with a 1 3/8" drill bit or hole saw.

\$ 56
package of 4

Available with white LEDs only



Deck Lights

Industrial strength solar powered dock light. Marine grade anodized aluminum offers superior protection in harsh marine environments.

\$ 37
each

Available with white LEDs only

BIRD•B•GONE™ Sea Gull Eliminators

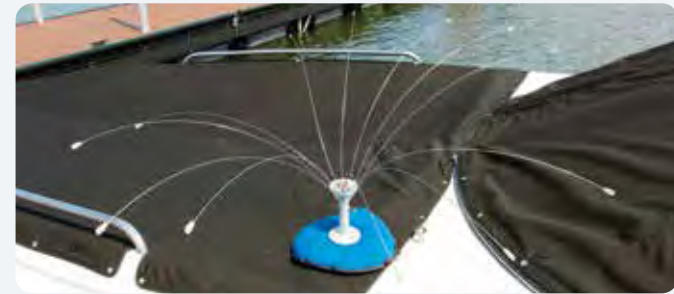

Bird Spider 360°

The spider's spinning motion is effective at deterring birds from landing on your boat, swim raft or dock. Stainless steel arms with scuff-preventing polycarbonate tips move with the breeze. Permanent glue-on base or use optional sandbag mount.

4' Diameter Spider \$ 49.⁹⁹ 8' Diameter Spider \$ 59.⁹⁹



Repeller 360°

6' diameter, wind driven rotator keeps birds from roosting on your boat, swim raft or dock. Includes standard mounting block (screws included). Portable sandbag mounts sold separately.

360 Repellent \$ 49.⁹⁹

Sandbag Base

Attaches directly to either style repeller (hardware included). Eyelets around outer ring for extra security. Weighs 8 lbs.

Sandbag Base \$ 41.⁹⁹



Options & Accessories : Seasonal Dock Adjustment Tools & Flag Poles

Adjustment Kit

Adjust the level of your dock with this kit that slides over the 1 1/2" leg pipe. Available for all leg & wheel docks with 1 1/2" pipe. Sold as a pair (winch with sleeve and hook).

\$ 339 / pair

See page 45 for our Mega Dock adjustment kit.

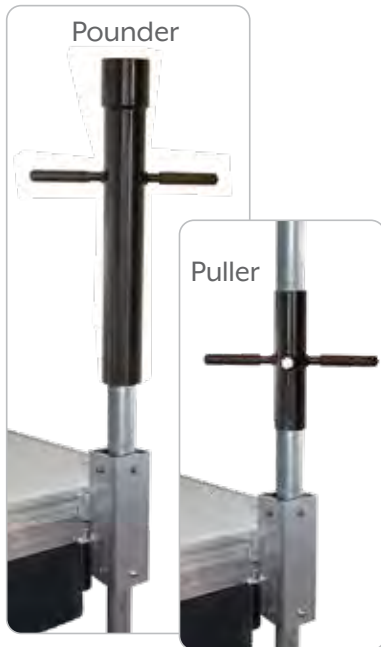

Spud Puller & Pounder Kit

This (2) piece system aids in the installation and removal of spud pole anchors for our floating dock systems.

2" puller/pounder kit: \$ 345

3" puller/pounder kit: \$ 435

16' Aluminum Telescoping Flag Poles

Add beauty to your waterfront property with a telescoping flagpole. Each section of the pole raises and lowers easily, and with no ropes, chains or pulleys they are virtually noise-free.



16' tall telescoping aluminum flagpole includes a 3" gold aluminum ball ornament, a double flag harness to fly two flags or fly at half mast, a 3' x 5' nylon USA flag with embroidered stars and sewn stripes. Other pole heights available as special order.

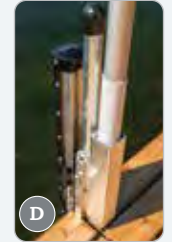
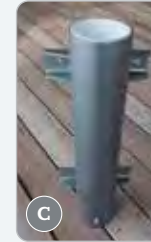

Flag Poles

| Style | Our Price |
|--|---------------|
| A1 Silver Finish 16' Flag Pole | \$ 359 |
| A2 Black Finish 16' Flag Pole | \$ 389 |
| Dock Mounts (for flagpoles) | |
| Our Price | |
| B Deck surface mount | \$ 129 |
| C Side mount | \$ 129 |
| D Pole mount for docks with 1 1/2" leg pipe | \$ 109 |

Options & Accessories : Ladders & Steps



Dock Ladders

(available for all dock systems)

One-piece, removable vertical ladder with 1 1/2" tubular aluminum frame and arched, slip resistant 4" treads for added comfort with bare feet. Treads are 17 1/2" wide.

| Stock Size | PRICE |
|------------|--------|
| 3' ladder | \$ 305 |
| 4' ladder | \$ 325 |
| 5' ladder | \$ 345 |



Shallow Water Stairs

(available for all leg & wheel docks)

One-piece welded aluminum structure with aluminum handrails down each side and non-slip treads with adjustable footpads. 19.50" wide treads/29" between rails/8" risers.

| Stair Size | Elevation ¹ | PRICE |
|------------|------------------------|--------|
| 4 step | 37" – 49" | \$ 795 |
| 5 step | 45" – 57" | \$ 845 |
| 6 step | 53" – 65" | \$ 895 |

¹Accommodates elevation from dock surface to lakebed.



Also suitable for accessing the shoreline from your dock.



Waterfront Access : Aluminum Stairs

Our lightweight aluminum stair kits are designed for a variety of applications. Offering a lifetime of virtually maintenance free features, these quality aluminum stairs are an economical solution for waterfront or hillside access and ideal solution to replacing your old wooden steps. Not recommended for in-water use.



Muskegon, MI

Aluminum Stair Features

- Readily available in lengths up to 18'
- Non-skid, 28" wide aluminum stair treads
- Rounded aluminum handrails on both sides
- Adjustable rise & run (27 to 44 degrees) to accommodate your site
- Marine grade aluminum extrusions with stainless steel fasteners (not recommended for in water use)
- Lightweight & easy to carry for a two-person installation
- Custom fabrication available for specific applications & lengths (see custom catalog or our website)
- Optional adjustable footpads for base of stairs
- Includes mounting bracket (designed for easy seasonal installation & removal of stairs)

Waterfront Access : Aluminum Stairs

Calculate shipping costs on our website at:

www.thedockdoctors.com/stair-kits



 4 and 6-step stairs ship UPS ground

 8 thru 16-step stairs ship freight



Optional adjustable footpad for uneven surfaces.

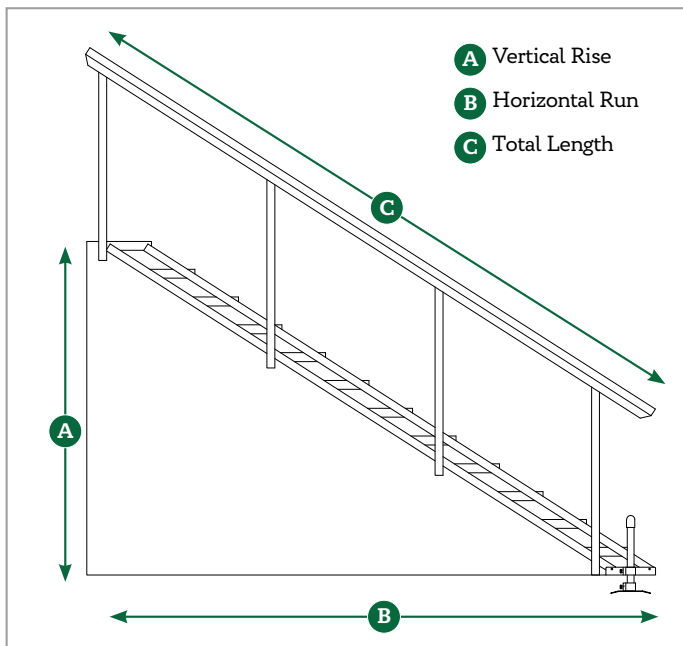

How to measure for stairs

A few simple measurements can help determine the recommended length of stairs for your particular site.

For tips on how to measure, visit our website at:

www.thedockdoctors.com/stair-kits

Aluminum Stairs

All stair treads are 28" wide

All stairs can be assembled to fit any distance between the minimum and maximum rise.

| # of Steps | Price* | MINIMUM RISE | | | MAXIMUM RISE | | | Weight |
|------------|----------|---|------------------|---------------------|-----------------|------------------|---------------------|----------|
| | | Rise @ 6" (27°) | Run with 6" rise | Length with 6" rise | Rise @ 9" (44°) | Run with 9" rise | Length with 9" rise | |
| 4 | \$ 955 | 2' 0" | 4' 7" | 5' 0" | 3' 0" | 3' 11" | 4' 11" | 70 lbs. |
| 6 | \$ 1,255 | 3' 0" | 6' 6" | 7' 2" | 4' 6" | 5' 6" | 7' 1" | 100 lbs. |
| 8 | \$ 1,555 | 4' 0" | 8' 5" | 9' 4" | 6' 0" | 7' 1" | 9' 3" | 122 lbs. |
| 10 | \$ 1,855 | 5' 0" | 10' 4" | 11' 6" | 7' 6" | 8' 8" | 11' 5" | 150 lbs. |
| 12 | \$ 2,155 | 6' 0" | 12' 3" | 13' 8" | 9' 0" | 10' 2" | 13' 7" | 174 lbs. |
| 14 | \$ 2,455 | 7' 0" | 14' 2" | 15' 10" | 10' 6" | 11' 9" | 15' 9" | 202 lbs. |
| 16 | \$ 2,755 | 8' 0" | 16' 1" | 18' 0" | 12' 0" | 13' 3" | 17' 11" | 225 lbs. |
| n/a | \$ 770 | 3' x 4' stair platform (standard duty aluminum with aluminum decking) | | | | | | 45 lbs. |

*Price includes mounting bracket (fasteners to existing platform not included); handrails down each side and slip resistant stair treads. Stair uprights remain vertical in any rise. Optional top and/or bottom stair platform in 3' x 4' standard duty aluminum. Optional pair of Adjustable Footpads includes brackets to mount to bottom of stairs, 1 1/2" aluminum support pipes 24" long, black safety caps & aluminum footpads. Requires stair frame drilling on-site to mount.



mounting bracket



rounded aluminum handrail



non-skid, 28" wide aluminum stair treads



(optional)

Adjustable Footpad
\$250 / pair

Requires drilling stair on-site to mount.



3' x 4' platform



Assembly Options: Unassembled: Requiring assembly on site to contour to desired rise (note: some drilling is required).

Pre-assembled: Factory assembled and adjusted to desired rise (note: additional assembly charge will apply).

*Prices do not include shipping/delivery. To calculate shipping to your location, please visit: www.thedockdoctors.com/stair-kits

Leg & Wheel Docks : Standard Duty Aluminum



Designed for smaller lakes and bays, our standard duty aluminum frame leg and wheel docks feature an exceptionally strong aluminum frame. Strong yet lightweight, these docks can be installed by one person.

Willsboro, NY



Standard Duty aluminum leg docks with WearDeck decking in Barefoot Sand. Shown with optional edge fender as an alternative to our vertical fenders.

Standard Duty Aluminum Leg & Wheel Docks

- Exceptionally strong aluminum frame
- Easy one-person install
- Support stanchions built into the frame for an obstruction-free dock edge
- Removable decking in Cedar, WearDeck or attached Sure-Step® decking
- Ipe hardwood decking option also available



EASY one person install



Our innovative connector clips and lightweight sections allow for one person to easily connect sections together and install the dock system.

Leg & Wheel Docks : Standard Duty Aluminum



Standard duty aluminum leg dock with composite decking, shallow water stairs (see page 18) and 4,500 lb. Vertical Boat Lift.



Our freestanding launch port system (see page 58 for more details).



Standard Duty aluminum wheel docks easily roll in and out seasonally or as the water fluctuates during the season.



Brant Lake, NY

WearDeck decking in Barefoot Sand.



Salisbury, VT



Kayak Roller (see p. 15)



Storage Racks (see p. 13)



Aluminum Ladders (see p. 18)

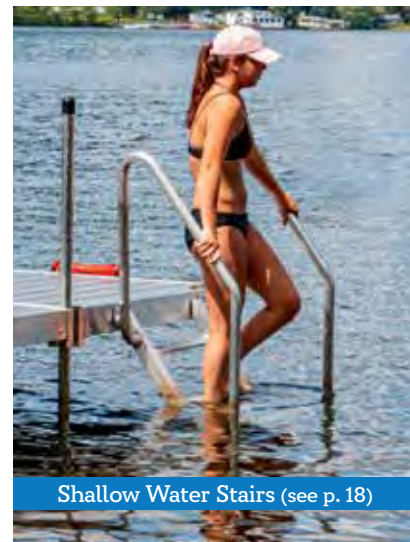

Shallow Water Stairs (see p. 18)

Leg & Wheel Docks : Standard Duty Aluminum



Watch a video and find out more at:
www.thedockdoctors.com/launch-port



Above & Above Left: Standard duty aluminum docks with cedar decking and our freestanding launch port system (see page 58 for more details).



Made in

the **USA**

Standard Duty Aluminum leg docks with cedar decking, then our Medium Duty Aluminum dock in 6 foot width serves as a shoreside platform.



Pick Up > We Pay
OF Free Delivery
see page 3

Standard Duty Aluminum Leg & Wheel Docks

See decking & color choices on page 8.

| Stock Size | Weight* | CEDAR | ALUMINUM | WEARDECK® | SURE-STEP® |
|--------------------|----------|---------|----------|-----------|------------|
| | | Price | Price | Price | Price |
| LEG DOCKS | | | | | |
| 4' x 8' | 49 lbs. | \$ 810 | \$1,105 | \$1,065 | n/a |
| 4' x 10' | 58 lbs. | \$ 940 | \$1,285 | \$1,235 | n/a |
| 4'3" x 8'5" | 103 lbs. | n/a | n/a | n/a | \$ 1,030 |
| 4'3" x 10'5" | 125 lbs. | n/a | n/a | n/a | \$ 1,180 |
| WHEEL DOCKS | | | | | |
| 4' x 12' | 95 lbs. | \$1,570 | \$1,989 | \$1,920 | n/a |
| 4'3" x 12'5" | 149 lbs. | n/a | n/a | n/a | \$1,850 |

Dock pricing includes frame and removable decking. Wheel dock pricing includes (1) pair of wheels and axle assembly. The necessary assembly components are sold separately. *Weights for docks do not include the decking with the exception of docks with Sure-Step® decking, which attaches directly to the dock frame and is not removable.

Assembly Components

Connector Clips
for connecting docks together
\$ 34 set of 2



Safety Cap
for 1 1/2" pipe
\$ 5.75 each



Aluminum Pipe 1 1/2"
cut to length pending water depth
\$ 9.50 per foot



Footpad
(aluminum)
\$ 46 each



Cross Braces
(optional)
stabilizes docks in deeper water
4 foot: **\$ 195**
6 foot: **\$ 205**
8 foot: **\$ 215**
10 foot: **\$ 225**



Size based on distance between support pipe.

Leg & Wheel Docks : Medium Duty Aluminum

Lake Dunmore, VT



Our medium duty aluminum frame leg and wheel docks offer superior strength and stability, featuring taller frames and longer and wider sections than our standard duty frames. Easy to install, the support stanchions are built into the frame and flush to the sides of the dock.



Silver Bay, NY

Medium Duty Aluminum Leg & Wheel Docks

- Exceptionally strong, 7" tall aluminum frame
- Support stanchions built into the frame, for an obstruction-free dock edge
- Removable decking panels in Cedar, WearDeck or Aluminum
- Ipe hardwood decking option also available



EASY TO INSTALL - No sharp edges on underside of frames make our aluminum docks easy on the hands for carrying.



Standard Duty vs. Medium Duty Frames

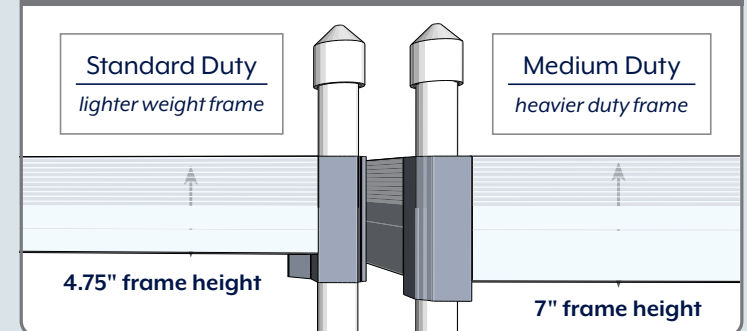

Leg & Wheel Docks : Medium Duty Aluminum



Above: Medium duty aluminum leg docks with cedar decking in a "U" shape.
Below: "U" shaped configuration with WearDeck decking in Barefoot Gray.



"L" shaped with WearDeck decking in Weatherwood.



"T" shaped with cedar decking.

Greensboro, VT



Made in

the USA



"Straight" dock with Aluminum decking.



Lake Bomoseen, VT

6 foot wide medium duty aluminum docks with composite decking (special order color) and 6,000 lb. vertical boat lift with Sunbrella canopy (see pp. 70-73). Accessories include shallow water stairs, vertical fenders and solar post lites.



Camp Twin Birches, Saranac Lake, NY

Leg & Wheel Docks : Medium Duty Aluminum

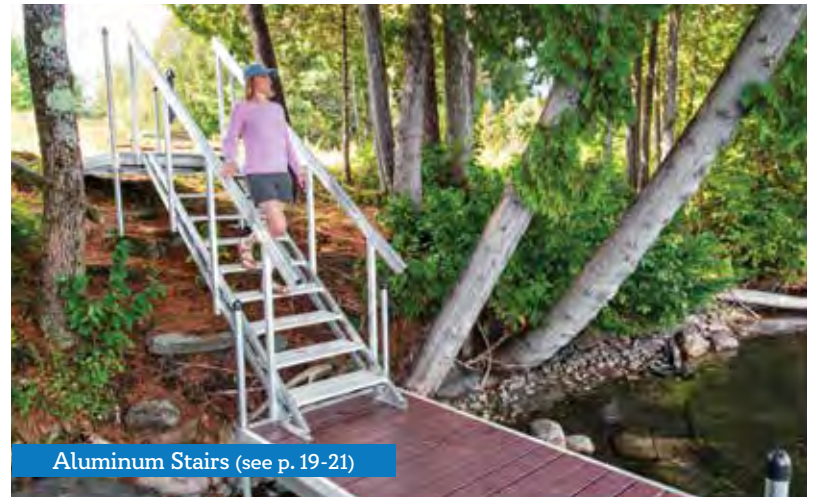

Aluminum Stairs (see p. 19-21)



Pipe Cleat (see p. 11)



Solar Post Lites (see p. 16)



Dock mounted roller (see p. 15)



Optional triangle section for more deck space.



6' x 8' Leg Dock
with removable deck panels



4' x 16' Wheel Dock
with removable deck panels



Medium Duty Aluminum Leg & Wheel Docks

See decking & color choices on page 8.

| Stock Size | Weight* | CEDAR | ALUMINUM | WEARDECK® |
|-------------------------|----------|----------|----------|-----------|
| | | Price | Price | Price |
| LEG DOCKS | | | | |
| 4' x 8' | 75 lbs. | \$ 1,040 | \$ 1,310 | \$ 1,270 |
| 4' x 10' | 89 lbs. | \$ 1,190 | \$ 1,530 | \$ 1,480 |
| 4' x 12' | 100 lbs. | \$ 1,325 | \$ 1,765 | \$ 1,680 |
| 6' x 8' | 93 lbs. | \$ 1,350 | \$ 1,745 | \$ 1,655 |
| 6' x 10' | 111 lbs. | \$ 1,545 | \$ 2,060 | \$ 1,930 |
| 6' x 12' | 125 lbs. | \$ 1,730 | \$ 2,345 | \$ 2,190 |
| 3' x 3' triangle corner | 30 lbs. | \$ 595 | \$ 625 | \$ 615 |
| WHEEL DOCKS | | | | |
| 4' x 16' | 156 lbs. | \$ 2,350 | \$ 2,880 | \$ 2,780 |
| 6' x 16' | 184 lbs. | \$ 2,645 | \$ 3,470 | \$ 3,240 |

Dock pricing includes frame and removable decking. Wheel dock pricing includes (1) pair of wheels and axle assembly. The necessary assembly components are sold separately. *Weights for docks do not include the decking.

Assembly Components

Connector Clips
for connecting docks together
\$ 46 set of 2



Safety Cap
for 1 1/2" pipe
\$ 5.75 each



Aluminum Pipe 1 1/2"
cut to length pending water depth
\$ 9.50 per foot



Footpad (aluminum)
\$ 46 each



Cross Braces (optional)
stabilizes docks in deeper water
4 foot: **\$ 195**
6 foot: **\$ 205**
8 foot: **\$ 215**
10 foot: **\$ 225**



Size based on distance between support pipe.

Leg & Wheel Docks : Heavy Duty Steel Truss

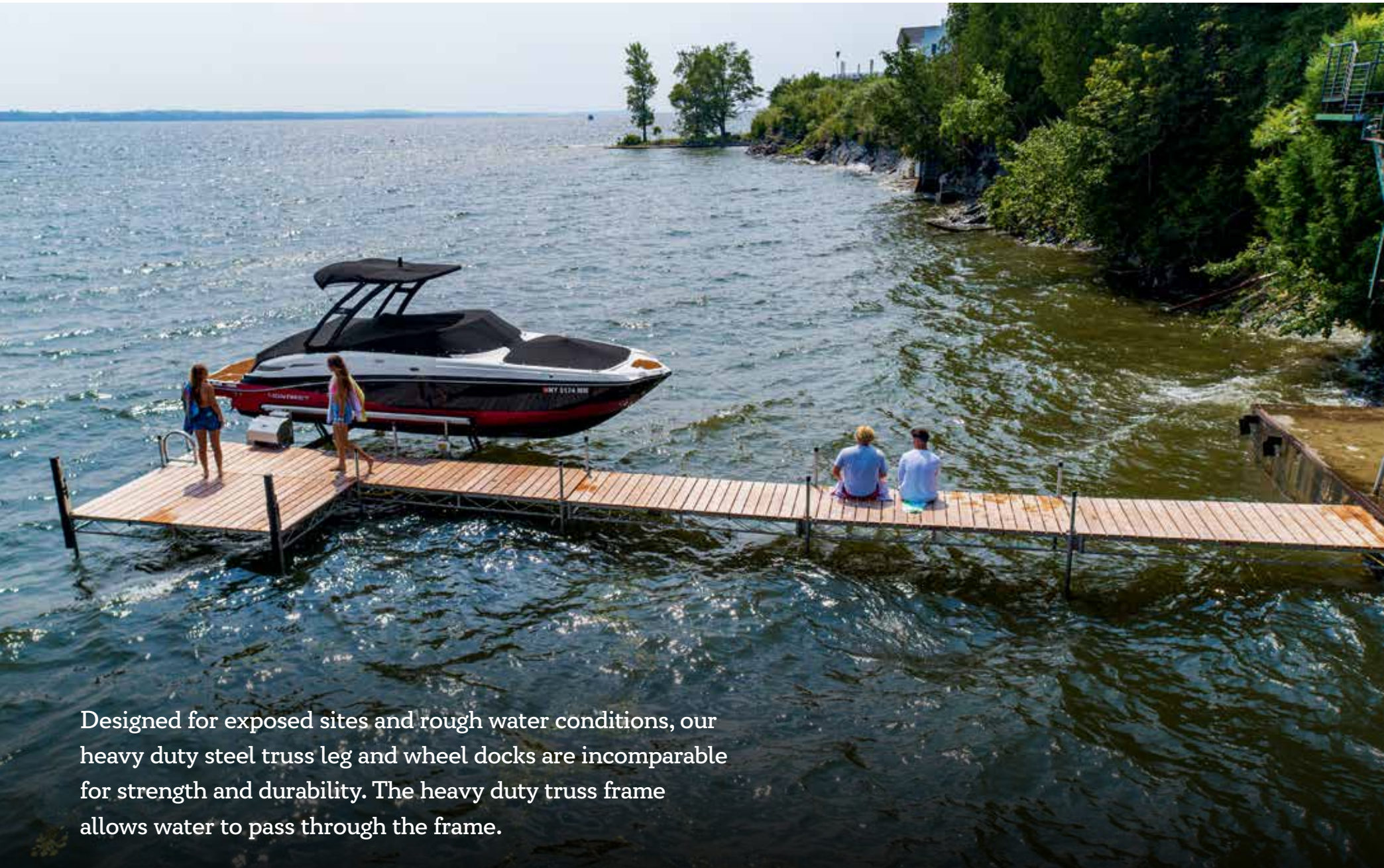

Designed for exposed sites and rough water conditions, our heavy duty steel truss leg and wheel docks are incomparable for strength and durability. The heavy duty truss frame allows water to pass through the frame.

Above: Heavy Duty Steel Truss Leg Docks with cedar decking in an "L" shaped configuration and 6,000 lb. capacity Vertical Boat Lift.



6' wide sections with WearDeck decking in Barefoot Gray, 6,000 lb. vertical boat lift with Sunbrella Canopy .

Heavy Duty Steel Truss Leg & Wheel Docks

- Designed for exposed sites
- Heavy duty 9" galvanized steel truss frame with adjustable leg stanchions built into frame
- Removable decking in Cedar or WearDeck
- Ipe hardwood decking option also available
- 10 year limited warranty



Designed for exposed sites

Leg & Wheel Docks : Heavy Duty Steel Truss

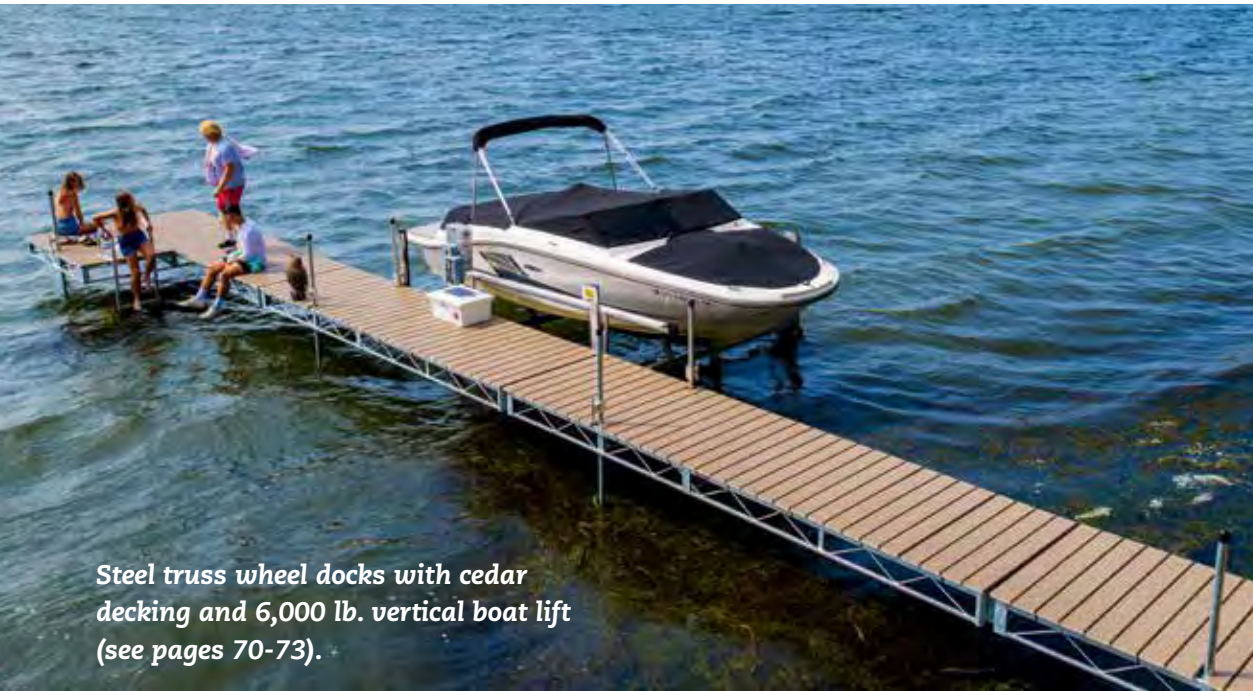

Steel truss wheel docks with cedar decking and 6,000 lb. vertical boat lift (see pages 70-73).



Steel truss leg docks in 6 foot width with WearDeck decking in Barefoot Sand.



Steel truss leg docks for a site with little shoreline and restrictions on distance into the water. Shown with our aluminum stairs (see pages 19-21).



Steel truss wheel docks with WearDeck decking in Barefoot Gray.



6' wide sections for more deck space.



Steel truss leg docks with Weatherwood WearDeck decking. Shown with lower access platform (page 14), 5' aluminum ladder (page 18) and vertical fenders (page 10).



3' x 3' triangle corner creates more deck space.



Leg & Wheel Docks : Heavy Duty Steel Truss



Steel truss leg docks in a "U" shape to create a boat slip. Custom aluminum canopy mounts and Sunbrella canopy.

Wells, VT



Shallow Water Stairs (p. 18)



Aluminum Stairs (pp. 19-21)



Lower Access Platform & Aluminum Ladder (p. 14)



Vertical Fenders (pp. 10-11) & Solar Post Lites (p. 16)



4' x 10' Leg Dock
with removable deck panels



4' x 16' Wheel Dock
with removable deck panels



Heavy Duty Steel Truss Leg & Wheel Docks

See decking & color choices on page 8.

| Stock Size | Weight* | CEDAR | WEARDECK® |
|-------------------------------|----------|----------|-----------|
| | | Price | Price |
| LEG DOCKS | | | |
| 4' x 8' | 100 lbs. | \$ 1,200 | \$ 1,445 |
| 4' x 10' | 115 lbs. | \$ 1,300 | \$ 1,590 |
| 6' x 8' | 125 lbs. | \$ 1,565 | \$ 1,865 |
| 6' x 10' | 145 lbs. | \$ 1,655 | \$ 2,055 |
| 2' x 10' catwalk (std duty**) | 75 lbs. | \$ 690 | \$ 830 |
| 3' x 3' triangle corner | 19 lbs. | \$ 425 | \$ 460 |
| WHEEL DOCKS | | | |
| 4' x 16' | 208 lbs. | \$ 2,590 | \$ 3,015 |
| 6' x 16' | 265 lbs. | \$ 2,920 | \$ 3,515 |
| 4' x 16' with 4' x 8' L | 316 lbs. | \$ 3,815 | \$ 4,450 |
| 6' x 16' with 4' x 8' L | 373 lbs. | \$ 4,155 | \$ 4,915 |

Dock pricing includes frame and removable decking. Wheel dock pricing includes (1) pair of wheels and axle assembly. The necessary assembly components are sold separately. *Weights for docks do not include the decking. **Catwalk shown on page 35, bottom right.

Assembly Components

Connecting Brackets

each connection requires (4)

End-to-end: \$ 18/ea

Side-by-side: \$ 18/ea

Catwalk (3"): \$ 15/ea

catwalk requires (2)

3" brackets & (2) truss

end-to-end brackets



Safety Cap

for 1 1/2" pipe

\$ 5.75 each

Galvanized

Pipe 1 1/2"

cut to length pending water depth

\$ 9.50 per foot



Footpad (galvanized steel)

\$ 48 each

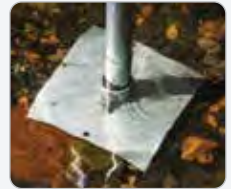

Dock Panel Securing Cord

\$ 6 set of 4



Cross Braces (optional) stabilizes docks in deeper water

4 foot: \$ 195

6 foot: \$ 205

8 foot: \$ 215

10 foot: \$ 225



Size based on distance between support pipe.

Leg & Wheel Docks : Mega Duty Steel Truss

Designed for use in rough and deep water applications, our mega duty steel truss leg and wheel docks feature taller frames, longer and wider sections, and larger diameter upright supports than our heavy duty steel truss dock systems. Available in two stock sizes (or contact us for custom dock size options).



*WearDeck decking
in Barefoot Gray*



Sliding Boat Boarding Step (see p.15)



Mega dock in an "L" shaped configuration with Ipe decking and 3' x 24' aluminum gangway.



Mega wheel dock with cedar decking.

Mega Duty Steel Truss Leg & Wheel Docks

- Designed for use in rough & deep water applications
- 11" tall galvanized steel truss frame
- 3" diameter upright supports
- Stocked in 6' x 20' & 8' x 20' sizes (custom sizes available)
- Adjustable leg stanchions built into frame
- Removable decking in Cedar or WearDeck
- Ipe hardwood decking option also available

Pick Up > We Pay
or Free Delivery

see page 3



Heavy Duty vs. Mega Duty Frames

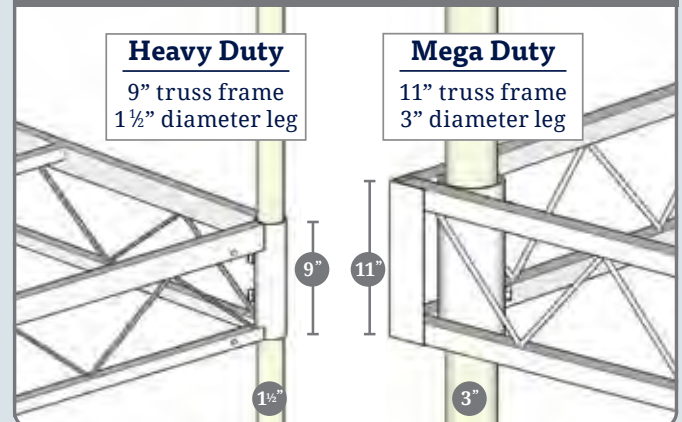

Leg & Wheel Docks : Mega Duty Steel Truss



Lake George, NY

Our Mega dock in a U-shaped configuration to create a boat slip. Shown with optional skirt boards to camouflage the steel truss frame and vertical fenders (see D on page 11). WearDeck decking in Saddle.



Above: Mega Duty dock system, accessed by our custom steel stairs and shoreside platform, which provides deck space on this steep shoreline (see our Custom Catalog).



**WearDeck decking
in Weatherwood**



Dock frames being manufactured in our Vermont Facility



Delivery of a mega dock system & boat lift to an island site.



**One of our crews
installing a mega
dock system.**

Leg & Wheel Docks : Mega Duty Steel Truss



Our Mega dock used as a shoreside access & mount for a custom floating dock (see our Custom Catalog). Ipe hardwood decking.



Mega Dock in a U-shaped configuration to create a boat slip. Custom aluminum canopy mounts and Sunbrella canopy in Forest Green.



6' x 20' Mega Duty Leg Dock
with removable deck panels



Mega Duty Steel Truss Leg & Wheel Docks

See decking & color choices on page 8.

| Stock Size | Weight* | CEDAR | WEARDECK™ | IPE hardwood |
|---------------------------|----------|---|-----------|-------------------------------|
| | | Price | Price | available as a special order. |
| LEG DOCKS | | | | |
| 6' x 20' | 418 lbs. | \$ 5,040 | \$ 5,710 | call for quote |
| 8' x 20' | 490 lbs. | \$ 6,745 | \$ 7,710 | call for quote |
| WHEEL KITS | | | | |
| for 6' wide docks: \$ 605 | | Dock pricing includes frame and removable decking. Wheel dock pricing includes (2) pairs of wheels and axle assembly. The necessary assembly components are sold separately. *Weights for docks do not include the decking. | | |
| for 8' wide docks: \$ 625 | | | | |

Assembly Components

Connecting Brackets
each connection requires (4)
\$ 34 each



Safety Cap
for 3" pipe
\$ 7.25 each



Galvanized Pipe 3"
cut to length pending water depth
\$ 18 per foot



Footpad
(galvanized steel)
\$ 64 each

Dock Panel Securing Cord
\$ 6 set of 4



Cross Braces
(not shown, optional stabilizes docks in deeper water)
\$ 230 (6' wide docks)
\$ 240 (8' wide docks)



Mega Dock Adjustment Kit
adjust the level of your dock with this kit that slides over the 3" leg pipe
\$ 589 pair

Floating Docks : Medium Duty Aluminum



Our medium duty aluminum floating docks feature our “aluminum track” frame, allowing for easy mounting of hardware and accessories. These pre-manufactured “stock” docks are readily available for pick up, delivery or installation and are designed to be easily installed for the do-it-yourselfer.



Above: Medium Duty aluminum floating docks with WearDeck decking in Weatherwood and a 3' x 24' aluminum gangway with aluminum treadplate for a seamless transition from shore to dock.



Medium Duty aluminum floating docks with cedar decking on a private pond.

Medium Duty Aluminum Floating Docks

- Used in residential & light commercial applications
- Exclusively designed frame by The Dock Doctors®
- Universal track-style 5" tall aluminum frame allows for easy mounting of hardware & accessories
- Removable decking panels in Cedar, Aluminum or WearDeck
- Ipe hardwood decking also available
- Black polyethylene flotation filled with expanded polystyrene



Plymouth, VT



Our unique float frame and hinge-system allow for a seamless transition from gangway/ramp to dock (no step down) & adjusts to fluctuating water levels.

Floating Docks : Medium Duty Aluminum



Spud Anchor Mount with Vertical Fender (see p. 11)





Made in

the USA



Above: Aluminum floating dock with aluminum decking and optional edge fender.



Schroon Lake, NY



Wheel mounts

Medium Duty aluminum floating dock with WearDeck decking in Weatherwood. Includes custom aluminum handrail and wheel mounts for ease of seasonal installation and removal.

Floating Docks : Medium Duty Aluminum



St. Johnsbury, VT

This dock system features a fixed to floating combination of dock styles for use on bodies of water that have fluctuating water levels. The transition piece (shown right) allows for horizontal movement while the floating dock can float up and down on the anchoring.



This floating dock is anchored using a hinge connection to existing shoreside deck and slackline to shore.



Our heavy duty aluminum docks with a 7" tall frame are ideal for sites with more exposure (see pages 4-5 & 51-53 in our Custom Catalog).



4' x 12' Medium Duty Aluminum Floating Dock with removable deck panels



Medium Duty Aluminum Floating Docks

See decking & color choices on page 8.

| Stock Size | Weight* | CEDAR | ALUMINUM | WEARDECK® |
|--|----------|----------|----------|-----------|
| | | Price | Price | Price |
| FLOATING DOCKS | | | | |
| 4' x 12' | 200 lbs. | \$ 2,080 | \$ 2,460 | \$ 2,395 |
| 4' x 16' | 260 lbs. | \$ 2,610 | \$ 3,130 | \$ 3,020 |
| 6' x 12' | 256 lbs. | \$ 2,810 | \$ 3,375 | \$ 3,220 |
| 6' x 16' | 368 lbs. | \$ 3,520 | \$ 4,280 | \$ 4,060 |
| 8' x 12' | 352 lbs. | \$ 3,470 | \$ 4,230 | \$ 4,040 |
| 8' x 16' | 503 lbs. | \$ 4,280 | \$ 5,300 | \$ 5,040 |
| RESIDENTIAL GANGWAY | | | | |
| 3' x 24' | 357 lbs. | \$ 4,400 | \$ 4,920 | \$ 4,800 |
| COMMERCIAL GANGWAYS available in any length/width with minimal time frames. | | | | |

Pricing includes frame, decking and flotation. Anchoring, connecting hardware and shore mount sold separately.
 Note: Docks used as a shore ramp may require adjustable float frame and shore connection pending layout.
 Ipe hardwood decking option available. *Weights for docks do not include the decking.

Assembly Components

Hinge Connector Kits

Hinge connector kits include bushing, stainless steel pins, wear and dampener system and protective cap (cap not shown).



\$ 215
(for 4' wide docks)

\$ 220
(for 6' wide docks)

\$ 225
(for 8' wide docks)

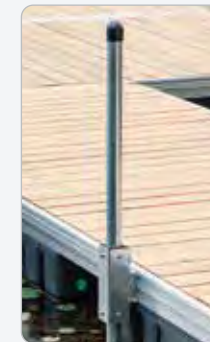

Safety Cap
for 2" pipe
\$ 6.²⁵ each

Galvanized Pipe 2"
cut to length pending water depth
\$ 14 per foot

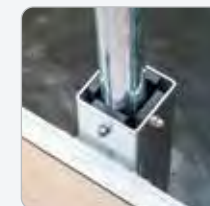

Anchor Mounts:
Spud Pole \$ 295
pipe sold separately

Chain Tube \$ 160
chain for anchoring sold separately

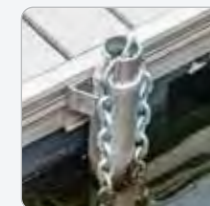

Chain \$ 4.⁹⁵ / ft.
3/8" galvanized

Floating Docks : Heavy Duty Aluminum Paddle Docks

Featuring heavy-duty aluminum frames, our paddle docks are suitable for commercial or residential applications. Their modular design allow for a variety of layout options.



angled ladder

10-12" freeboard

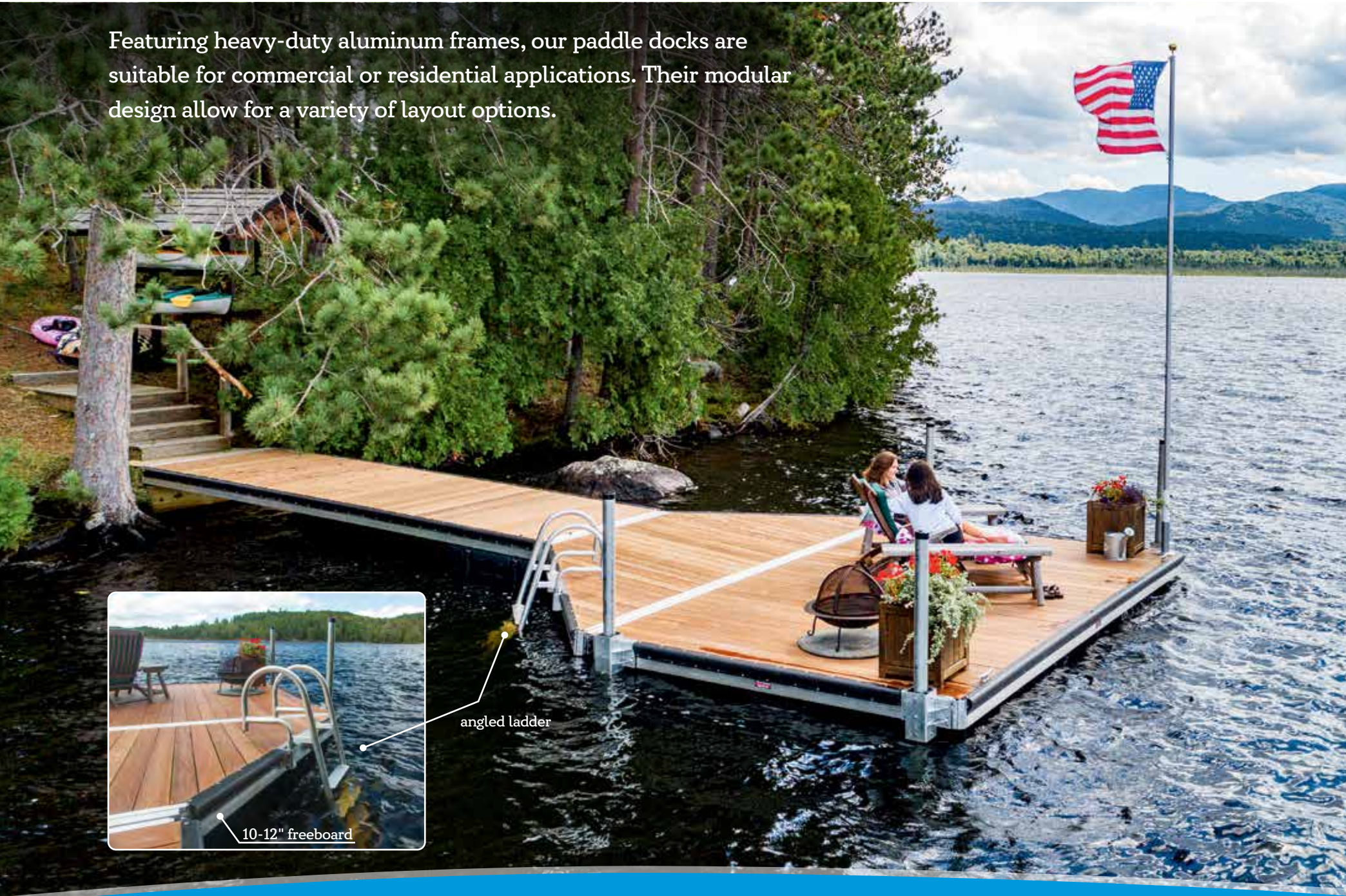

Paddle Docks (Heavy Duty Aluminum)

- 7" Aluminum Track Frame (with 10"- 12" freeboard, approximate – pending sections, size & decking choices)
- Heavy duty, stainless-steel connection hinges
- Optional powder coated frame
- Cedar decking, or upgrade to optional Ipe or WearDeck decking
- Black polyethylene flotation filled with expanded polystyrene
- Optional marine-grade black vinyl edge fender



Heavy duty aluminum paddle dock at a State Park. Shown with optional vinyl edge fender and WearDeck decking in Barefoot Sand.

Low freeboard for easy paddle craft boarding.

Paddle Docks Heavy Duty Aluminum

| Standard Size <i>with cedar decking</i> | Price |
|---|--------------------------|
| 8' × 20' | as low as \$7,775 |
| 10' × 20' | as low as \$9,485 |
| 8' × 16' ramp section | as low as \$5,935 |
| Angled Dock Ladder <i>(aluminum)</i> | \$ 515 |

Custom sizes and wider ramps available. Standard pricing includes aluminum frame, cedar decking and flotation. Site conditions, exposure, anchoring details and ramp requirements to be determined for final pricing.

Please note: Our Aluminum Paddle Docks are not "stocked" items and do not qualify for Free Delivery or Pickup and Save. Please contact us for pricing and delivery/pickup time frames.



10' × 20' paddle dock, 8' × 16' ramp section with Ipe decking and optional angled ladder.

Paddle Craft
LAUNCHES • LIFTS • RACKS

Floating Docks : Heavy Duty Aluminum Rowing Docks



Our heavy-duty, aluminum-frame rowing docks feature a modular design that allows for a variety of layout options. Suitable for commercial or residential applications.



- 7" Aluminum Track Frame with 6"- 8" freeboard
- Heavy duty, stainless-steel connection hinges
- Modular track-style frame for multiple layout options
- Black polyethylene flotation filled with expanded polystyrene
- Cedar decking, or upgrade to optional Ipe or WearDeck
- Optional marine grade black vinyl edge fender
- Optional debris diverter to protects the dock from floating debris often seen in river settings

Rowing Docks Heavy Duty Aluminum

| Standard Size | Price |
|------------------------------|--------------------------|
| 8' × 20' | as low as \$7,775 |
| 10' × 20' | as low as \$9,485 |
| 8' × 16' ramp section | as low as \$5,935 |
| 8' × 20' flared ramp section | as low as \$7,900 |

Standard pricing includes heavy duty aluminum frame, cedar decking and flotation. Custom sizes and wider ramps available.

Site conditions, exposure, anchoring details and ramp requirements to be determined for final pricing.

Please note: Our Aluminum Rowing Docks are not "stocked" items and do not qualify for Free Delivery or Pickup and Save. Please contact us for pricing and delivery/pickup time frames.



Above: Heavy duty aluminum frame Rowing Dock with 38' × 7' aluminum gangway and commercial kayak launch with ADA transfer platform (see page 57). Our custom pile dock serves as a shore anchor.



Hinge Connections
as low as **\$ 449**



Edge Fender
\$ 13.⁵⁰ per foot installed



Debris Diverter
starting at **\$ 3,679**



Axle & Wheel Mounts **\$1,095/set**
for seasonal installation & removal



Angled Ladder **\$ 515**

Paddle Craft Launch Docks: Residential & Commercial Floating Launch Docks



Find out more at: www.thedockdoctors.com/dock-and-launch-residential

Residential Dock & Launch System

- Medium-duty 5" tall universal track-style frame.
- Polyethylene flotation filled with expanded polystyrene.
- Sure-Step non-skid surface on the launch platform.
- Boarding handle and grab and launch bars.

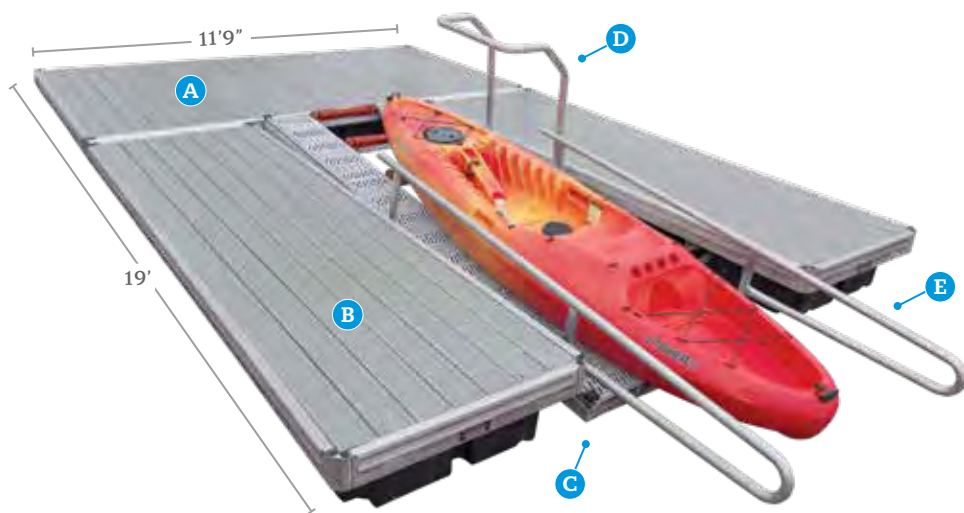

Dock & Launch System Medium Duty Residential

Featuring a 5" tall aluminum frame, and 19' x 11'9" overall size, our medium duty dock and launch system includes:

- A** (1) main frame (7' x 11' 9")
- B** (2) dock fingers (12' x 3' 6")
- C** Launch ramp (4' x 12')
with built-in rollers & Sure-Step® non-skid decking
- D** Boarding handle
- E** Grab and launch rails

*** as low as \$ 15,995**

*Site conditions, anchoring & decking selection are necessary to determine final pricing. Please call for a free estimate.

Please note: Our floating Dock & Launch Systems are not "stocked" items and do not qualify for Free Delivery or Pickup and Save. Please contact us for pricing and delivery/pickup time frames.

Commercial Dock & Launch System

- Heavy-duty 7" universal track-style frame (meets commercial & municipal quality standards).
- Can be used as a complete system or in conjunction with any of our custom floating dock systems.
- Sure-Step non-skid surface on the launch platform.
- Boarding handle and grab and launch bars.
- Optional ADA accessible options include transfer platform, ADA curbing and rails.

Optional ADA Transfer Platform



Mowhak River, NY

▶ Video and more details at: www.thedockdoctors.com/commercial-launch

Dock & Launch System Heavy Duty Commercial

Featuring a 7" tall aluminum frame, and a 20'3" × 19' overall size, our heavy duty commercial dock and launch system includes:

- | | |
|---|--------------------------------|
| A (1) main frame (7' × 19') | D Boarding handle |
| B (2) dock fingers (7' × 13' 4") | E Grab and launch rails |
| C Launch ramp (4' 4" × 15') with built-in rollers & Sure-Step® non-skid decking | * as low as \$ 24,750 |

*Site conditions, anchoring & decking selection are necessary to determine final pricing. Please call for a free estimate.

Please note: Our floating Dock & Launch Systems are not "stocked" items and do not qualify for Free Delivery or Pickup and Save. Please contact us for pricing and delivery/pickup time frames.

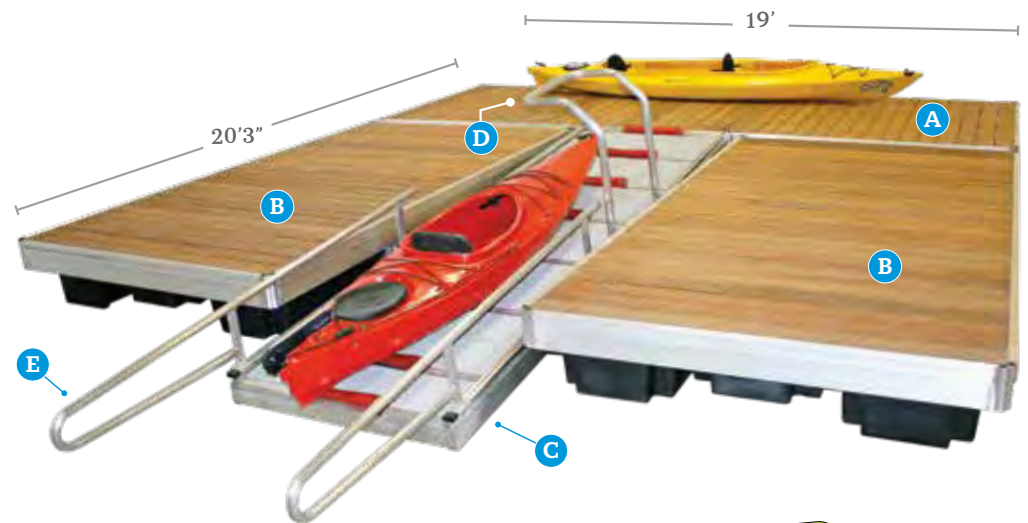

Paddle Craft Launch Docks & Lifts : Easily board & launch your paddle craft

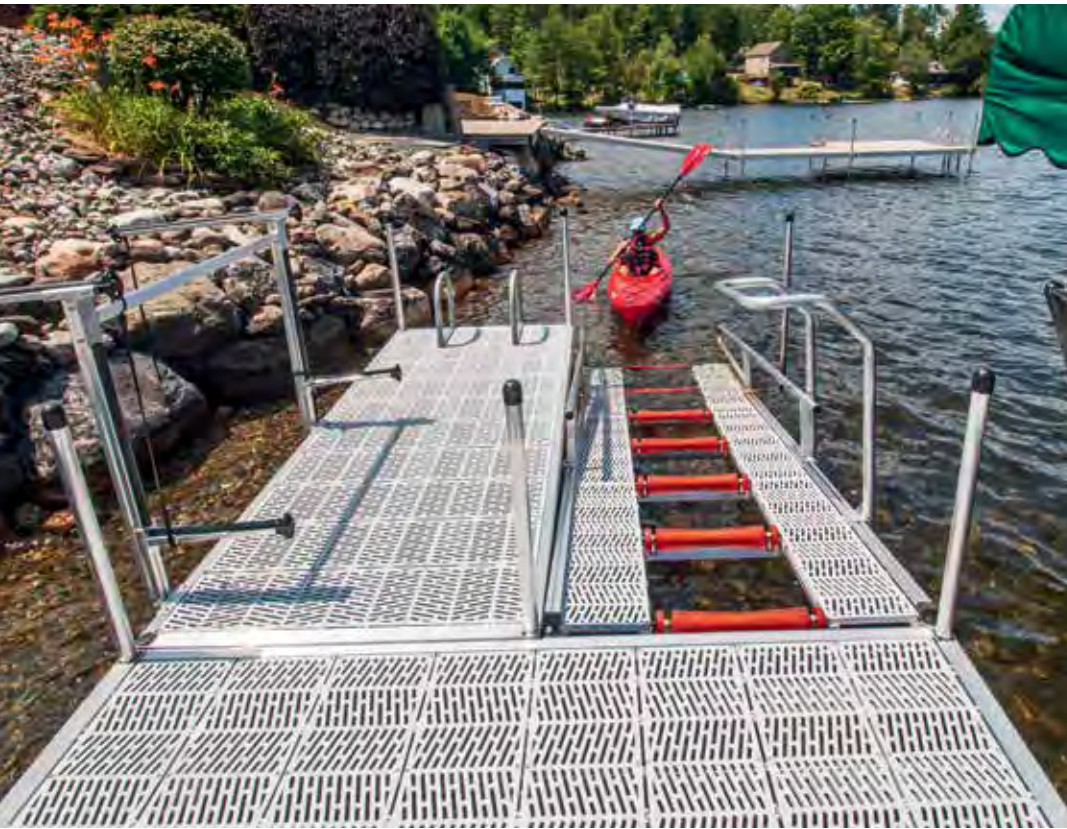

Ideal for controlled bodies of water with minimal water fluctuation, our freestanding Launch Port System makes boarding and launching your craft a breeze.

Freestanding Launch Port System

- Ideal for controlled bodies of water with minimal fluctuation
- Fixed height non-skid Sure-Step® platform
- Non-marring Stoltz® rollers
- Includes (2) standard duty leg dock sections and launch ramp – custom layouts available for your specific site
- Optional grab and launch rails offer more control when gliding on and off the launch platform



A Boarding Handle (optional)



B Grab & Launch Rails (optional)

Freestanding Launch Port

Standard Duty Aluminum

Base unit includes:

(1) 4' × 8' & (1) 4' × 10' standard duty leg dock sections and (1) 4' × 12' launch ramp.

Item

Freestanding Launch Port System

A Boarding handle (optional)

B Grab & launch rails (optional)

SURE-STEP®

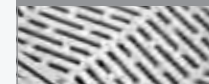

Price

\$ 5,800

\$ 415

\$ 695

Pipe for upright supports sold separately pending water depth and lengths required.

Launch Port Lift

If your water levels fluctuate, our Launch Port Lift raises up to 75" so the water is never out of reach.

- Non-marring Stoltz® rollers
- Non-skid Sure-Step® platform
- Stainless steel fasteners & cables
- 30" handwheel raises & lowers the platform
- 18" adjustable legs (other lengths available)
- Assembly service available (additional fee)



▶ Watch a video and find out more at: thedockdoctors.com/launch-port-lift

Launch Port Lift Specs

| | |
|----------------------|----------|
| Lifting Height | 75" |
| Overall Width | 73" |
| Overall Length | 144" |
| Weight with platform | 400 lbs. |

Launch Port Lift

| Item | Price |
|---|-----------------|
| Launch Port Lift (unassembled) | \$ 6,950 |
| A Boarding Handle (optional) | \$ 415 |
| B Grab & Launch Rails (optional) | \$ 695 |



A Boarding Handle (optional)



B Grab & Launch Rails (optional)



Paddle Craft Lift : Residential Small Craft Lifts

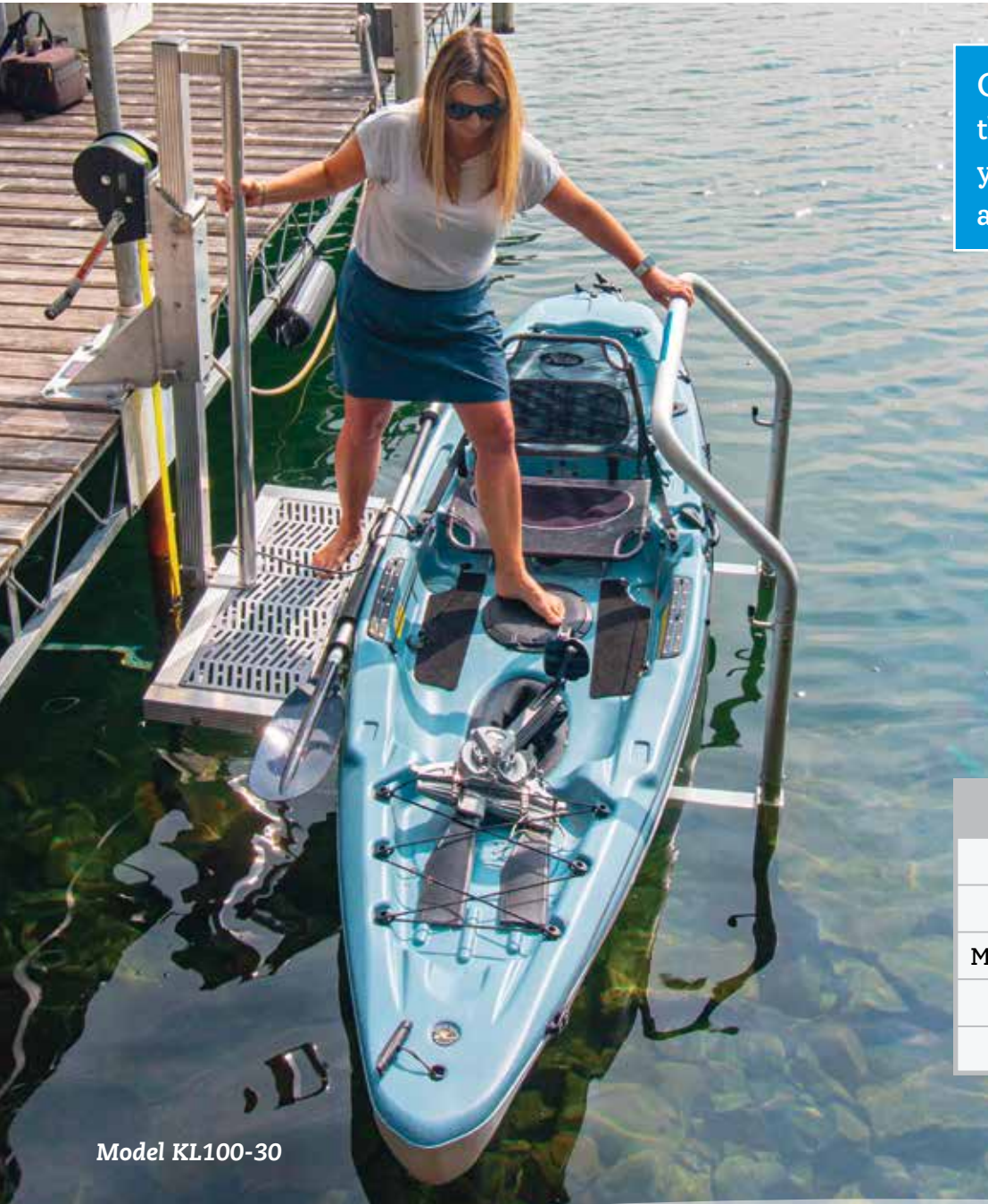

Model KL100-30

Our innovative Kayak Lift & Launch features a platform that raises and lowers so you can safely and easily launch your kayak from a seawall or dock. Available in 3 models to accommodate different lifting heights and craft weights.

Kayak Lift & Launch Specifications

- Mounts to seawalls or docks
- Manual winch raises and lowers the platform
- Sure-Step® UV resistant decking on platform
- Boarding handle with built-in paddle storage hooks
- Adjustable aluminum & vinyl bunks
- Three models available
- FREE UPS shipping on models KL100-30 & KL100-66L
- Model KL400-72L ships freight visit our website for shipping costs to your location

| MODEL | A KL100-30 | B KL100-66L | C KL400-72L |
|----------------------|-------------------|--------------------|--------------------|
| Lifting Height | 30" | 66" | 72" |
| Max Craft Weight | 100 lbs. | 100 lbs. | 400 lbs. |
| Max Craft Beam Width | 38" | 38" | 51" |
| Ladder | NO | YES | YES |
| UPS Shippable* | YES | YES | NO (ships freight) |

*FREE shipping on KL100-30 and KL100-66L within the continental USA. Optional accessories subject to regular ground shipping costs. Shipping additional for Model KL400-72L, please visit our website to calculate shipping cost to your location. Custom lifting heights available, contact us for details.



Watch a video of the kayak lift at:
www.thedockdoctors.com/ladder-lift-launch



Lower launch platform and craft.



Transition down the ladder.



Board your craft.



Glide smoothly off.

FREE
shipping



For sites that are a minimal distance off the water, model KL100-30 Kayak Launch has a lifting height of 30" and can accommodate crafts up to a 38" beam width. Includes manual winch, boarding handle, kayak leash and adjustable bunks.

\$2,300 

FREE
shipping



Model KL100-66L features a built-in ladder and has a lifting height of 66" and can accommodate crafts up to 38" beam width. Includes manual winch, boarding handle, kayak leash and adjustable bunks.

\$2,940  Ships FREE within the continental USA

SHIPS
freight 

This model will accommodate the Hobie Mirage® Tandem



Designed for larger crafts the KL400-72L Kayak Launch features a built-in ladder and has a lifting height of 72" and can accommodate crafts up to 51" beam width. Includes manual winch, boarding handle, kayak leash and adjustable bunks.

\$4,035  Ships FREIGHT (shipping additional)

Optional Accessories



Kayak Roller: Assists in moving your kayak onto the bunks. Bolts to side of platform. Cannot be used in combination with Top Transition Step. **\$230**



Top Transition Step: Provides a platform for an easier transition to the ladder or the launch platform. Also assists with loading and unloading your craft. **\$360**



Concrete Installation Kit: For installation on concrete surface. Note: Requires an electric hammer drill with concrete bit sized for the rod listed.

KL100 kit: \$110

KL400 kit: \$119

Paddle Craft
LAUNCHES • LIFTS • RACKS

Paddle Craft Storage Racks : Accessories for storing your paddle crafts

Marine-grade aluminum frame small craft storage racks. Available in freestanding, wall mounted, and dock mounted styles. Featuring arms with vinyl hull guards and end caps with built-in tie-down openings.

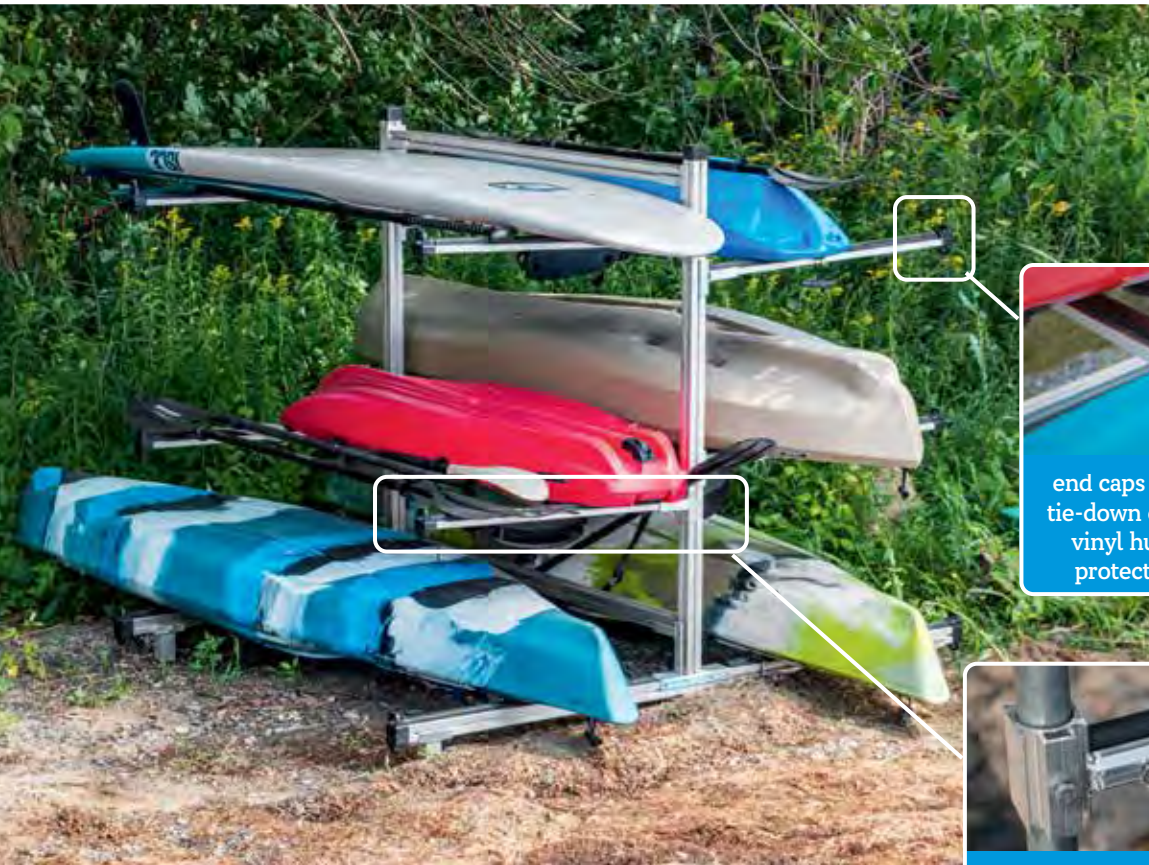

A Double side 6-craft rack.

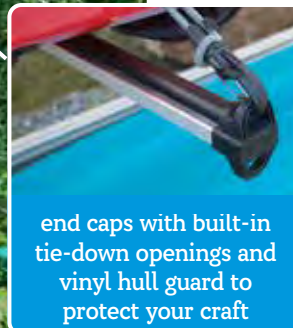

end caps with built-in tie-down openings and vinyl hull guard to protect your craft



adjustable arms with eye-bolts for securing tie-downs

Residential Aluminum Storage Racks

- Lightweight aluminum frame storage racks for storing canoes, kayaks, paddle boards and other small crafts
- Adjustable height arms with vinyl hull guards (additional arms available for custom configurations)
- Custom end caps with built-in tie down openings (tie-downs sold separately)
- Crafts can be secured with a cable and lock (not included).
- Stainless steel hardware

Optional Accessories

Adjustable Feet

Ideal for uneven ground. Includes 2 feet, mounting brackets and hardware.

\$205 (pair)



Additional Support Arms

Includes 2 arms, mounting brackets and hardware.

\$145 (pair)



Tie-Down Bungees

Adjustable-length (10 - 48") with a wrap-and-lock system so you can adjust the tension without unclipping the ends.

\$24 (pair)





| Storage Racks | | | | | MARINE GRADE ALUMINUM |
|-------------------------------------|----------------|-------------|------------------------|------------------------|-----------------------|
| Storage Rack Style | Craft Capacity | Unit Weight | (W x D x H) Dimensions | Arm Length | PRICE |
| A Double-Sided Rack | 6-crafts | 102 lbs. | 80" x 69" x 67" | 35" | \$ 1,175 |
| B Single-Sided Rack | 3-crafts | 76 lbs. | 49" x 69" x 67" | 35" | \$ 879 |
| C Mini Rack (double-sided)** | 3-crafts | 42 lbs. | 43" x 56" x 38" | upper 34" lower 18" | \$ 615 |
| D Wall-Mounted Rack | 3-crafts | 44 lbs. | var.† x 38" x 84" | 35" | \$ 655 |
| E Adjustable Feet (pair) | n/a | 10 lbs. | | | \$ 205 |
| F Additional Arms (pair)†† | n/a | 8 lbs. | | 35" | \$ 145 |
| G Tie-Down Bungees (pair) | n/a | n/a | | | \$ 24 |

All racks include allen wrench for assembly and adjustment of arm positions. Shipping or Delivery additional - please call for pricing or visit our website. *Assembly service available (additional charge) for racks that are picked-up or delivered only. **Double-sided mini rack is designed as a space saver and requires crafts to be positioned slightly angled on the bottom of the rack. †Wall mount rack dimensions are as follows: Width is variable depending upon installation, Depth is from wall to end of arm. ††Additional arms not available for (C) Mini Rack.



Paddle Craft Storage Racks : Structurally designed for commercial use



A Freestanding Commercial Rack in standard aluminum finish.

Commercial Storage Racks

Our commercial / municipal storage racks are manufactured with marine-grade aluminum frames and are available in standard aluminum or black powder coated finish.

- Adjustable height arms with vinyl hull guards
- Custom end caps with built-in tie-down openings (tie-downs sold separately)
- Additional arms available
- Standard aluminum or optional black powder coated finish
- Freestanding and concrete mount models
- We can customize any of our storage racks for your specific needs

| Commercial Storage Racks | | | | | STANDARD ALUMINUM | POWDER COATED BLACK |
|--------------------------------------|------------------|-------------|------------------------|------------|-------------------|---------------------|
| Storage Rack Style | Storage Capacity | Unit Weight | (W × D × H) Dimensions | Arm Length | PRICE | PRICE |
| A Freestanding (Double-Sided) | 8-crafts | 221 lbs. | 93" × 69" × 83" | 35" | \$ 2,440 | \$ 3,079 |
| B Concrete Mount | 8-crafts | 172 lbs. | 76" × 69" × 72" | 35" | \$ 2,285 | \$ 2,889 |
| C Additional Arms (pair) †† | | 18 lbs. | | 35" | \$ 320 | \$ 390 |

*All racks include allen wrench for assembly and adjustment of arm positions. Shipping or delivery additional - please visit our website or call for pricing. * Assembly service available (additional charge) for racks that are picked-up or delivered only. Note: Concrete bases not included.*

Note: Paddle craft should be stored upside-down to prevent collection of water inside the craft.

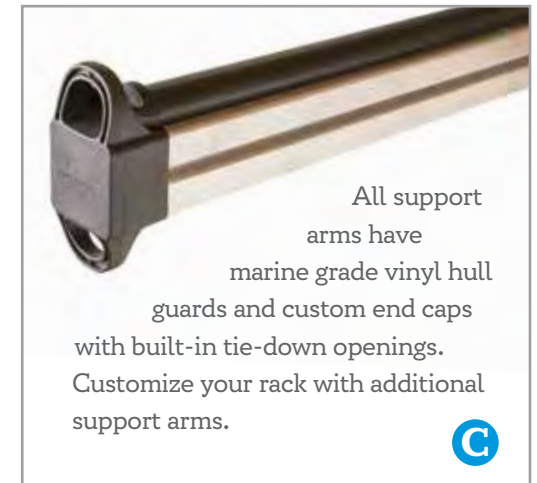



B

Concrete mounted base for secure, permanent installations (concrete bases not included).



B

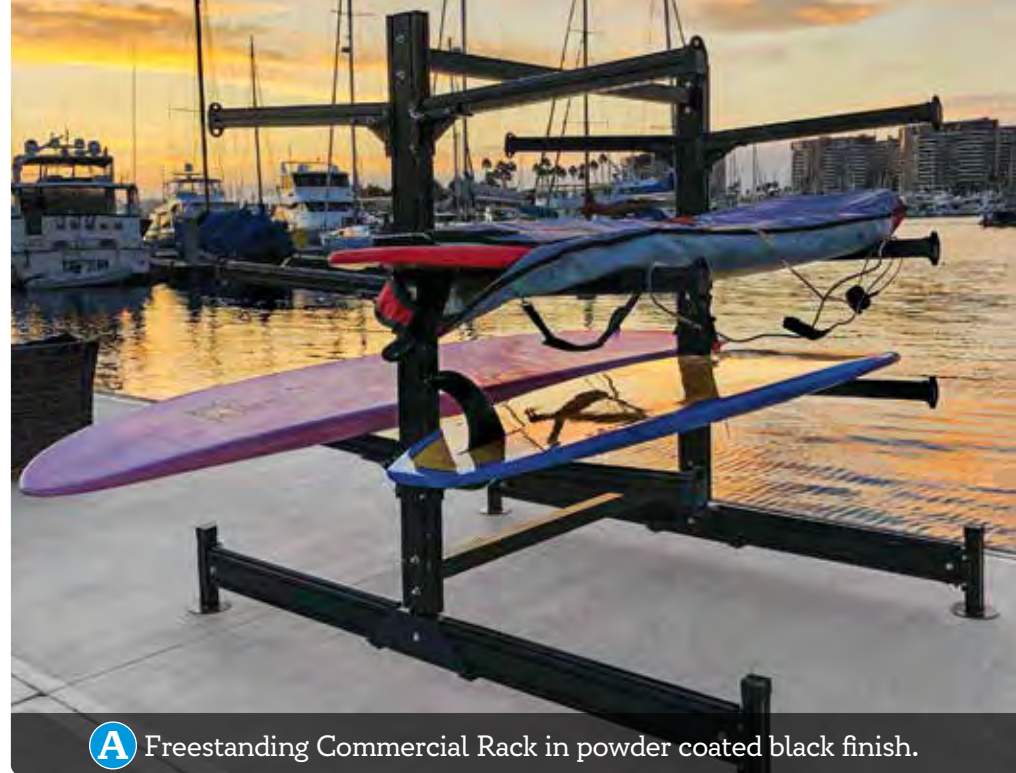

A

Freestanding Commercial Rack in powder coated black finish.



C

additional arms

Freestanding Commercial Rack with additional arms to store more crafts

Paddle Craft
LAUNCHES • LIFTS • RACKS

Paddle Craft Trailer : 4' x 5' aluminum trailer for transporting your paddlesport gear

Our Aluminum Paddlesport Trailer is fully-assembled and manufactured with marine-grade, one-piece aluminum frames. Our high-quality, easy to tow, functional trailer will safely transport and store all of your paddling gear.



LED lighting



Load bars with custom end caps with built-in tie-down loops & vinyl hull guard included



Adjustable tongue

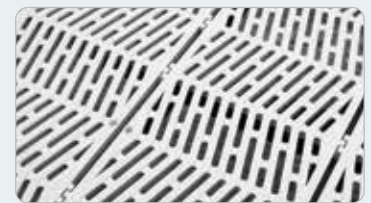

Sure-Step® decking on trailer bed

Optional Load Bar Extender Kit



Stands up for storage



We ship our trailers to anywhere in the continental US





Optional Accessories

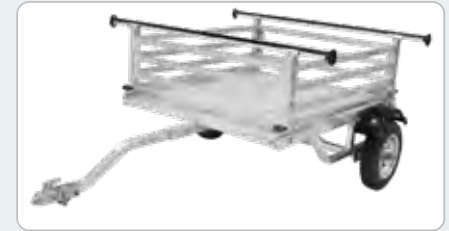

Trailer Sideboards

Turn your trailer into a full utility trailer with these removable, marine-grade aluminum sideboards. Sideboards are 16" high from the trailer bed and include brackets for mounting load bars. **\$590**

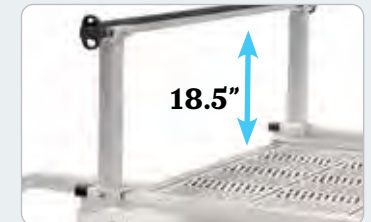

Load Bar Extender Kit

This kit raises the load bars from 11" to 18.5" above the trailer bed, allowing room for more gear. **\$215**



Spare Tire and Mount

DOT approved two-ply 12" trailer tire with tongue mount. **\$185**

Paddle Craft
LAUNCHES • LIFTS • RACKS

4' x 5' Deluxe Trailer

\$2,790

4' x 5' Deluxe Trailer
with standard height removable load bars
model # T45DSS

| | |
|-------------------------------|------------------------|
| Axle | torsion |
| Load Bar Length | 72" |
| Coupling Size | 2" |
| Tire Size | 12" |
| Unloaded Weight | 250 lbs. |
| GVWR maximum operating weight | 900 lbs. |
| Load Capacity | 650 lbs. |
| Overall Length | 11' 7" tongue extended |
| | 8' 7" tongue retracted |
| Bed Height | 24" ground clearance |
| | 11" load bar clearance |

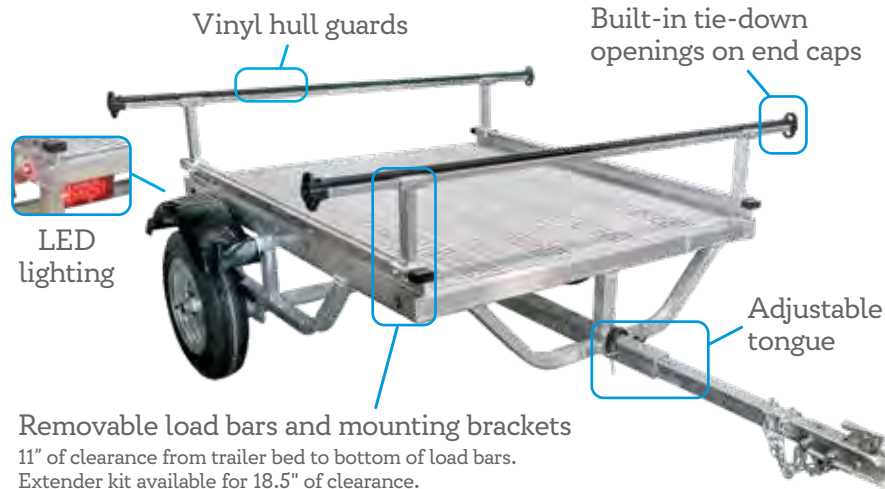

Removable load bars and mounting brackets
11" of clearance from trailer bed to bottom of load bars.
Extender kit available for 18.5" of clearance.

Shipped assembled - prices do not include shipping.



PWC & Small Craft Lifts

- 1,000 lb. & 1,200 lb. capacity cantilever models
- Stainless steel hardware & cables
- Polymer pulley sheaves prolong cable life
- Dual mounting winch (left or right side)
- 15 Year Limited Warranty
- 1,250 lb. vertical & 2,000 lb. hydraulic models also available (see Vertical Lift section on p. 71 or Hydraulic Lift section on p. 74)
- Manufactured by RGC®



Ideal for all types of smaller watercraft.

| Model Capacity | PL1000 1,000 lbs | PL1200 1,200 lbs |
|----------------------------|---------------------|---------------------|
| Max. Beam | 64" | 70" |
| Lifting Height | 46" | 46" |
| Bed Length | 72" | 96" |
| Min. Water Depth | 9" | 10" |
| Overall Width | 72" | 80" |
| Adjustable Legs | (4) @ 18" | (4) @ 18" |
| Shipping Weight | 155 lbs | 257 lbs |
| Price (assembled) | \$ 2,536 | \$ 3,402 |
| Price (unassembled) | \$ 2,336 | \$ 3,102 |



Boat Lifts : Boat Access & Seasonal Service Tools

Sliding Boarding Step



Shipping Available

Dock mounted sliding boarding step that bridges the gap between your dock and your boat. Easily slides and retracts so you can safely board your boat from your dock. Extends approximately 20" depending on the mounting location on the dock and includes a safety handrail that mounts to either side of the platform. Great for people AND pets! **\$ 1155** (ships UPS ground)

Boat Lift Installation & Removal Tools

Make the seasonal installation and removal of your boat lift easier with a wheel kit and/or air bag lift system.

Boat Lift Wheel Kits

Specifically designed for use with RGC® boat lifts and can be modified for use with hydraulic boat lifts. Includes a pair of welded galvanized steel mounting brackets and a pair of heavy duty polyethylene wheels (BLW5075 kit comes with 4 wheels).

BLW2045 (fits 2,000 - 4,500 lb. lifts): **\$ 415 / pair**

BLW5060 (fits 5,000 - 6,000 lb. lifts): **\$ 430 / pair**

BLW5075 (fits 5,000 - 8,000 lb. lifts): **\$ 585 / pair**



Air Bag Lift Kits / Boatlift Tubes

Inflatable 250 and 500 lb. capacity air bags designed to float your boat lift for seasonal installation and removal. Ideal when used in conjunction with a wheel kit (see photo on left).

250 lb. capacity: **\$ 350** / enclosed pillow lift bag

500 lb. capacity: **\$ 550** / enclosed pillow lift bag

500 lb. capacity: **\$ 675** / boatlift tube

Each kit includes (1) lift bag or (1) tube with a connecting kit (carabiner and strap). Airbag inflates with air compressor with a standard 1/4" NPT air fitting.

Boat Lifts : Vertical Lifts



Vertical boat lifts for any size and style boat:

- All stainless steel hardware & cables
- High lifting range
- Minimal water required
- Manufactured by RGC®
- 15 year limited warranty
- Delivery & installation available

*Above: 4,500 lb. boat lift manual handwheel. Below Left: 4500 lb. capacity vertical boat lift with extreme max D/C drive and solar power box.
Below Right: 6000 lb. capacity vertical boat lift with A/C direct drive and A/C power.*



Aluminum Vertical Boat Lifts

| Model # | Weight Capacity | Max. Beam | Overall Width | Overall Length | Lifting Height † | Min. Water | Shipping Weight | Dock Doctors Price (assembled) | Dock Doctors Price (unassembled) |
|---------------|-----------------|-----------|---------------|----------------|------------------|------------|-----------------|--------------------------------|----------------------------------|
| VL1250* | 1,250 lbs | 65" | 73" | 82" | 75" | 8.5" | 233 lbs | \$ 4,868 | \$ 4,568 |
| VL20100 | 2,000 lbs | 100" | 108" | 100" | 66" | 9.5" | 249 lbs | \$ 5,882 | \$ 5,382 |
| VL45108 | 4,500 lbs | 108" | 116" | 116" | 68" | 8" | 507 lbs | \$ 8,836 | \$ 8,236 |
| VL45116 | 4,500 lbs | 116" | 124" | 116" | 68" | 8" | 510 lbs | \$ 9,107 | \$ 8,507 |
| VL45116 T | 4,500 lbs | 116" | 124" | 116" | 80" | 8" | 523 lbs | \$ 9,378 | \$ 8,778 |
| VL50124 T | 5,000 lbs | 124" | 133" | 132" | 80" | 9" | 597 lbs | \$ 10,063 | \$ 9,463 |
| VL60124 T | 6,000 lbs | 124" | 133" | 132" | 80" | 9" | 663 lbs | \$ 10,535 | \$ 9,935 |
| VL80124 T ††† | 8,000 lbs | 124" | 133" | 132" | 78" | 11" | 777 lbs | \$ 15,501 | \$ 14,701 |
| VLS100132 ††† | 10,000 lbs | 132" | 152" | 158" | 78" | 11" | 1,030 lbs | \$ 24,277 | \$ 23,277 |

All pricing is F.O.B. our facility in Ferrisburgh, VT. Prices are for in stock product only. Additional freight charges may apply for special orders. Boat lift prices include (4) adjustable 29" legs with footpads and carpeted pressure treated bunks. Manual handwheel is included with non-electric models. Add desired pontoon or tritoon kit to the lift models as shown on page 73. *Lift includes 18" legs. †††Lifts include AC Direct Drive with remote control and double carpeted wood bunks.
 † Measured from top of load tubes to bottom of feet when adjustable legs are fully retracted. Measurements are approximate.



We can even deliver your boat lift assembled



note: wide load fee applies.

See page 73 for pricing and details on the pontoon and tritoon cradle kits.



4500 lb. boat lift with pontoon cradle kit



6000 lb. boat lift with tritoon cradle kit

Boat Lifts : Vertical Lift Accessories

A Vertical Lift Guides & B Extension Legs

| Lift Models | Lift Guides <i>Aluminum & Carpeted</i> | Vertical Lift Extension Legs | |
|-------------|---|---------------------------------|----------------------|
| | Tall Lift Guides adjusts from 25"– 43 ½"high | Ext. Legs 4' pair | Ext. Legs 6' pair |
| 3500/4500 | \$ 1,096 | \$ 353 | \$ 447 |
| 5000 | \$ 1,104 | \$ 353 | \$ 447 |
| 6000 | \$ 1,104 | \$ 353 | \$ 447 |
| 8000 | \$ 1,144 | \$ 353 | \$ 447 |
| 10,000 | \$ 1,449* | \$ 366 (5' pair) | \$ 880 (7' pair) |

*Note: The guide on option for this lift is carpeted only, not aluminum and carpeted.



Electric Drive Units

| Lift Models | AC Drive Systems | | | | DC Drive Systems | | |
|-------------|------------------|--------------------|--------------------|-------------------------|--------------------|--------------------|-------------------------|
| | C Direct | Direct with remote | Extreme Max Manual | Extreme Max with remote | Direct with remote | Extreme Max Manual | Extreme Max with remote |
| 4500 | \$ 2,590 | \$ 3,650 | \$ 1,778 | \$ 2,243 | \$ 4,200 | \$ 1,778 | \$ 2,243 |
| 5000 | \$ 2,590 | \$ 3,650 | \$ 1,778 | \$ 2,243 | \$ 4,200 | \$ 1,778 | \$ 2,243 |
| 6000 | \$ 2,574 | \$ 3,450 | \$ 1,778 | \$ 2,243 | \$ 4,050 | \$ 1,778 | \$ 2,243 |

Note: Drives listed are for lifts with R18 winches only. Please inquire for pricing and information on electric drives for D&L winches.



Direct A/C drive with manual switch

C Direct Drive This direct drive uses an industrial oil bath gear reducer and motor with a stainless steel cover which connects to the standard winch. Available with a remote control option. Available as an AC or DC unit.

D Extreme Max Drive System Manual key or optional remote control operation with a backup bit for manual operation of the unit in the event of a power outage. Comes complete with mounting kit.

E VL Solar Power Box Portable solar power source for waterfront owners with no electricity. Lightweight white fiberglass box holds (2) deep cycle batteries with a power source on/off switch. Available as solar or with an A/C trickle charger. **Solar charged: \$ 1,690 A/C charged: \$ 1,630**

F Elevated Power Box Stand This stand provides protection for your power box from heavy wave action or high water. Aluminum frame provides 15" of height above the deck surface. **\$ 1,630 Power box not included in price.**



Extreme Max D/C drive with remote control and solar power box



Elevated power box stand



Pacific Blue



Cadet Grey



Forest Green

Traditional canopies shown, please visit our website for other style options available:
www.thedockdoctors.com/canopies

Traditional Sunbrella® Boat Lift Canopies

| Lift Models | Description | Price |
|-------------------------|-------------|----------|
| 35108/45108 | 21' × 108" | \$ 4,971 |
| 35108/45108 | 24' × 108" | \$ 5,374 |
| 45116 | 24' × 116" | \$ 5,478 |
| 45116 | 26' × 116" | \$ 5,620 |
| 45116 | 28' × 116" | \$ 6,161 |
| 40124/50124/60124/80124 | 24' × 124" | \$ 5,609 |
| 40124/50124/60124/80124 | 26' × 124" | \$ 5,862 |
| 40124/50124/60124/80124 | 28' × 124" | \$ 6,430 |
| 40124/50124/60124/80124 | 30' × 124" | \$ 6,646 |
| 100132 | 32' × 132" | \$ 7,095 |

Prices include aluminum canopy frame & fabric in standard colors:
 ● Pacific Blue ● Cadet Grey ● Forest Green ● Heather Beige ● Slate



Signature colors available as a special order at an additional cost.
 Additional costs for shipping may apply for canopies not in stock.

Pontoon & Tritoon Cradle Kits

| Lift Model | Pontoon Cradle & Guide Kit | Tritoon Cradle & Guide Kit | Pontoon Deck Kit |
|------------|----------------------------|----------------------------|------------------|
| 4500 | \$ 1,397 | \$ 1,825 | \$ 903 |
| 5000 | \$ 1,532 | \$ 2,028 | \$ 924 |
| 6000 | \$ 1,681 | \$ 2,204 | \$ 924 |
| 8000 | n/a | \$ 2,271 | n/a |



Pontoon Cradle & Guide Kit



Pontoon Deck Kit

Boat Lifts : Hydraulic Lifts



- Available from 2,000 to 18,000 lb. capacity
- Stainless steel hardware
- Aluminum hydraulic cylinders with stainless steel fittings and hose assemblies
- Full length vinyl bunks
- Pontoon & Tritoon kits available
- Solar or AC charging options
- Manufactured by RGC®
- 15 year limited warranty

- 1 Adjustable width bunks: for a custom fit of your boat hull
- 2 Lateral adjustment: optimize the distance of your lift in relation to your dock.
- 3 Height adjustment: get the right height for your water depth.

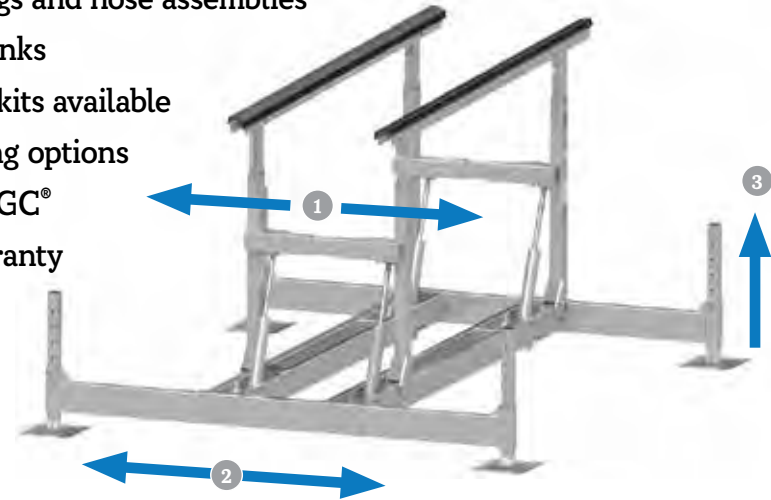

Hydraulic Aluminum Lifts

| Boat Lift Model # | Weight Capacity | New HL Flex Feature | Maximum Beam Width (center to center) | Maximum Lifting Height † | Minimum Bunk Height | Overall Width (including feet) | Overall Length (including feet) | # of Hydraulic Cylinders | Dock Doctors Price | |
|-------------------|-----------------|---|---------------------------------------|--------------------------|---------------------|--------------------------------|---------------------------------|--------------------------|--------------------|-------------|
| | | | | | | | | | UNASSEMBLED | ASSEMBLED |
| HL20065-60 | 2,000 lbs. | No | n/a | 48" | 24.5" | 74" | 119" | 1 | \$ 8,374 | \$ 8,644 |
| HL60120-48 | 6,000 lbs. | Yes | 44.5" | 48" | 29" | 137" | 198" | 2 | \$ 13,784 | \$ 14,264 |
| HL70120-60 | 7,000 lbs. | Yes | 44.5" | 60" | 34" | 137" | 209" | 2 | \$ 15,194 | \$ 15,674 |
| HL90120-60 | 9,000 lbs. | Yes | 50.5" | 60" | 31" | 141" | 211" | 4 | \$ 20,436 | \$ 21,156 |
| HL120132-60 | 12,000 lbs. | No | n/a | 60" | 36" | 152" | 297" | 4 | \$ 30,131 | \$ 31,091 |
| HL180144-60 | 18,000 lbs. | please call for information and pricing | | | | | | | please call | please call |
| HL240144-60 | 24,000 lbs. | please call for information and pricing | | | | | | | please call | please call |
| HL360144-60 | 36,000 lbs. | please call for information and pricing | | | | | | | please call | please call |

Package prices above include (4) 3' legs, battery, AC charger & remote control. Solar charging also available for all lifts. All pricing is F.O.B. our facility in Ferrisburgh, Vermont. Prices are for in stock product only. Additional freight charges may apply for out of stock items and special orders. See page 3 for delivery information. † Measured from top of bunks to bottom of feet when adjustable legs are fully retracted. Measurements are approximate.

Pontoon and Tritoon kits available for Hydraulic Lifts - contact us for options and pricing.



Two hydraulic lifts inside a boathouse.



2,000 lb. capacity hydraulic lift.

HL Boat Lift Accessories: Guides, Extension Hoses and Extension Legs

| Lift Model | Aluminum & Wood Guides | Rollers | Stainless Ext. Hose 12' pair | Stainless Ext. Hose 20' pair | Ext. Legs 5' pair | Ext. Legs 7' pair w/ bracing | 9' pair w/ bracing |
|------------|------------------------|---------|------------------------------|------------------------------|-------------------|------------------------------|--------------------|
| 6000-7000 | \$ 2,010 | \$ 163 | \$ 624 | \$ 718 | \$ 366 | \$ 1,179 | \$ 1,368 |
| 9000 | \$ 2,010 | \$ 163 | \$ 624 | \$ 718 | \$ 366 | \$ 1,179 | \$ 1,368 |
| 12,000 | \$ 4,308 | \$ 163 | n/a | n/a | \$ 366 | \$ 1,382 | \$ 1,558 |

* Guides for 12K lift model are available in aluminum and vinyl only.



Traditional canopy shown above. Please visit our website for other style options available: www.thedockdoctors.com/canopies

Traditional Style Canopies for Hydraulic Lifts

| Size | Price |
|-------------------|----------|
| 24' x 124" Canopy | \$ 5,258 |
| 26' x 124" Canopy | \$ 5,511 |
| 28' x 124" Canopy | \$ 6,079 |

Note: Prices include standard color Sunbrella® Fabric (● Pacific Blue, ● Cadet Grey, ● Forest Green, ● Heather Beige & ● Slate). Optional and signature colors are available as a special order (additional cost).



Canopy Leg Kits

| Size | Price |
|---------------------------------|----------|
| 4' Canopy Leg Kit with 8' posts | \$ 1,422 |
| 6' Canopy Leg Kit with 8' posts | \$ 1,639 |
| 8' Canopy Leg Kit with 8' posts | \$ 1,964 |

All pricing is F.O.B. our facility in Ferrisburgh, VT. Prices are for in stock product only. Additional freight charges may apply for special orders.

Boat Lifts : Ultimate Vertical Lifts

Ideal for boats from 6,000 to 32,000 lbs, our Ultimate Vertical Boat Lifts are manufactured with industrial quality hot-dipped galvanized steel. This lift is designed to be used in shallow, deep and fluctuating water applications. The 12,000 lb. and larger models are custom fabricated in modular sections for ease of seasonal handling.



24,000 lb. capacity Ultimate Lift

Ultimate Vertical Boat Lifts by The Dock Doctors

- Vertical lifts from 6,000 lb. to 32,000 lb. capacity
- 9 ft. standard lift height (other heights available)
- Great for shallow or deep water applications
- Adaptable to boathouses for use with permanent docks
- High lift for rough water & fluctuating water levels
- 12,000 lb. & larger models fabricated in modular sections to facilitate the initial installation
- Industrial quality hot dipped galvanized steel construction, stainless steel cables & galvanized fasteners
- Custom heights, widths & lengths are available to accommodate your boat & location



Lake George, NY

Above: 24,000 lb. capacity Ultimate Lift with custom front end bow stop & optional oil bath drives. Below: 15,000 lb. capacity Ultimate Lift with standard 7' vertical guide poles with PVC sleeves.



Ultimate Lift loaded and ready for delivery and installation.



Lake Winnepesaukee, NH

Boat Lifts : Ultimate Vertical Lifts



Pilot Knob, NY



Above: 12,000 lb. capacity Ultimate Lift installed in a slip within a boathouse with standard vertical guides & upgraded oil bath drives.



18,000 capacity Ultimate Lift with custom canopy.

AC drives and Gem remote controls are standard features on our Ultimate Lifts.



Dock Doctors® Ultimate Vertical Boat Lifts

| Model # | Capacity | # of Drives | Maximum Beam | Lifting Height | Overall Width | Overall Length | Price* |
|---------------------------------------|-------------|-------------|--------------|----------------|---------------|----------------|-----------------|
| STOCKED MODELS | | | | | | | |
| 6000 | 6,000 lbs. | 2 | 9' | 9' | 11' | 12' | \$ 16,300 |
| 9000 | 9,000 lbs. | 2 | 10' | 9' | 12' | 13' | \$ 18,300 |
| CUSTOM MODELS | | | | | | | |
| 12000 | 12,000 lbs. | 4 | 10' 7" | 8' 9" | 13' | 14' | call to inquire |
| 18000 | 18,000 lbs. | 4 | 11' 6" | 8' 9" | 14' | 16' | call to inquire |
| 24000 | 24,000 lbs. | 4 | 13' | 8' 11" | 16' | 18' | call to inquire |
| 32000 | 32,000 lbs. | 4 | 14' | 8' 11" | 17' | 20' | call to inquire |
| Auto Stop System (recommended option) | | | | | | | call to inquire |

Custom sizes are available.

*6K and 9K prices above include Gem remote control, sealed bearing and grooved cable winders, AC drives, (4) 7' vertical guide poles with PVC sleeves, (4) 24" adjustable legs and heavy-duty bunks with vinyl hull guard. Optional oil bath drives and full length guide-ons are available. Please inquire for pricing.



Above Left: 6000 lb. capacity Ultimate Lift being installed with our workboat "Miss Doc" and service crew.

Boat Lifts : Boathouse Lifts, Specialty Lifts, Custom Canopies

We custom fabricate Lifts for all types of sites & situations: For more information, visit our website at: www.thedockdoctors.com/custom-boat-lifts



Above: Bunk-style cradle system with pull-out tubes in place for winter storage.



Sling-style system for shallow water applications.



Above: Our Ultimate Lift customized to attach to the shore with galvanized lift arms allowing it to be raised for winter storage.



Above: Seaplane lift utilizing a stock hydraulic lift with a custom turntable platform.

Custom aluminum canopy mounts to attach standard RGC canopies to our Mega dock



Installation Service ~ Let the Waterfront Specialists do it for you!



We provide service to all areas in the Northeast



Our portable workboats from 24'-40' in length allow us to provide installation for our products throughout the Northeast.



The Dock Doctors^{LLC}

Waterfront Specialists



Take a virtual tour of our facility at:
www.thedockdoctors.com/tour



800-870-6756
www.thedockdoctors.com
info@thedockdoctors.com

Vermont Showroom & Manufacturing Facility
19 Little Otter Lane, Route 7, Ferrisburgh, VT 05456



*Open
year-round!*

Open Year-Round
Monday–Friday: 9am–4:30pm
Saturday: 9am–1pm (April 20th thru July 20th)
Closed Memorial Day Weekend and 4th of July

Lake Placid / Saranac Lake Product Display
876 State Route 86, Ray Brook, NY 12977



*Product Display
Visit Anytime*

Outdoor product display
No Staff - No Hours - Come by anytime
Located midway between Lake Placid & Saranac Lake